

Model:WBZ106E  
Service code:WBZ106E2012  
Chair Part

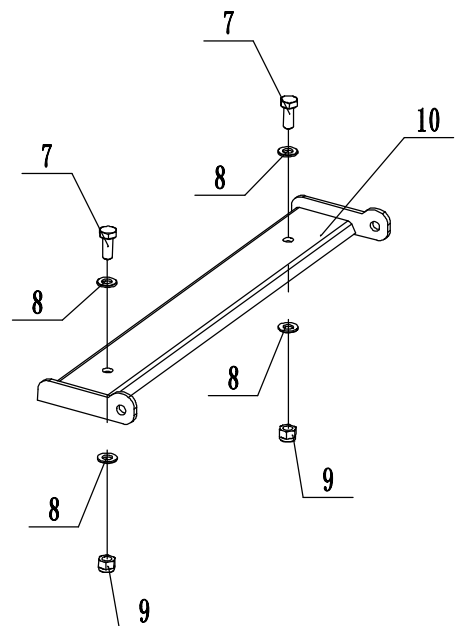

1	Ersatzteilliste		WBZ 106 E	2025
Nr.	Ersatzteilnummer	Bezeichnung Deutsch	Bezeichnung Englisch	Anzahl
1	Z42EA01000	Sitz	Seat	1
2	0202010000	Sicherungsmutter	Lock Bolt - M10	4
3	0301010000	Scheibe	Washer - 10x2	8
4	Z42EA02000/22	Platte	Seat mounting plate	1
5	Z61B1100	Sitzfederung	Shock absorber	2
6	0103010030	Schraube	Screw - M10x30	4
7	0101008020	Bolzen	Bolt - M10x20	4
8	0301008000	Unterlegscheibe	Washer - 8x1.6	8
9	0202008000	Sicherungsmutter	Lock Nut - M8	4
10	Z42EA03000/22	Sitzhalter	Seat mounting plate	1

Model:WBZ106E  
Service code:WBZ106E2012  
Shell part

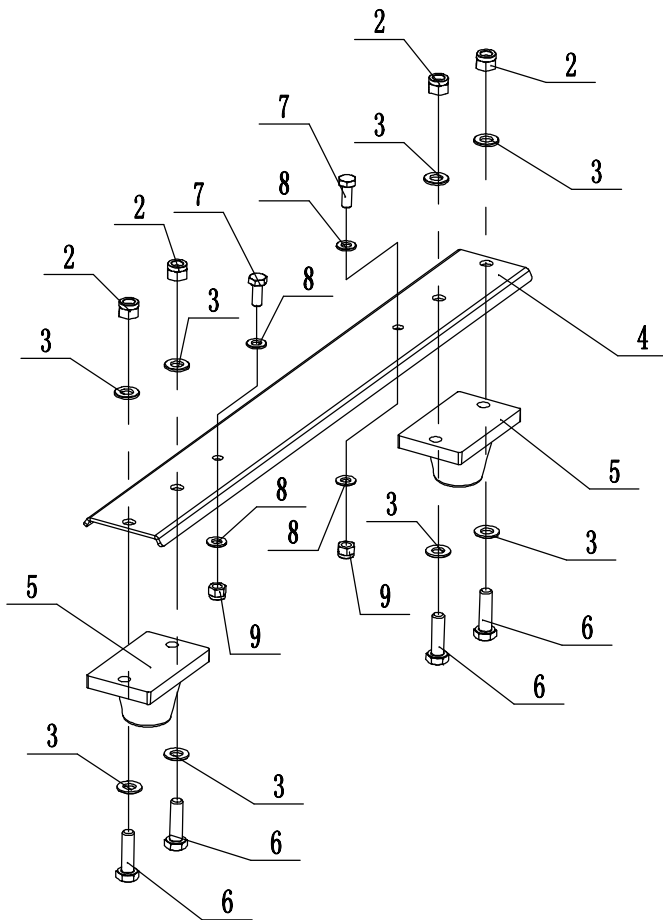
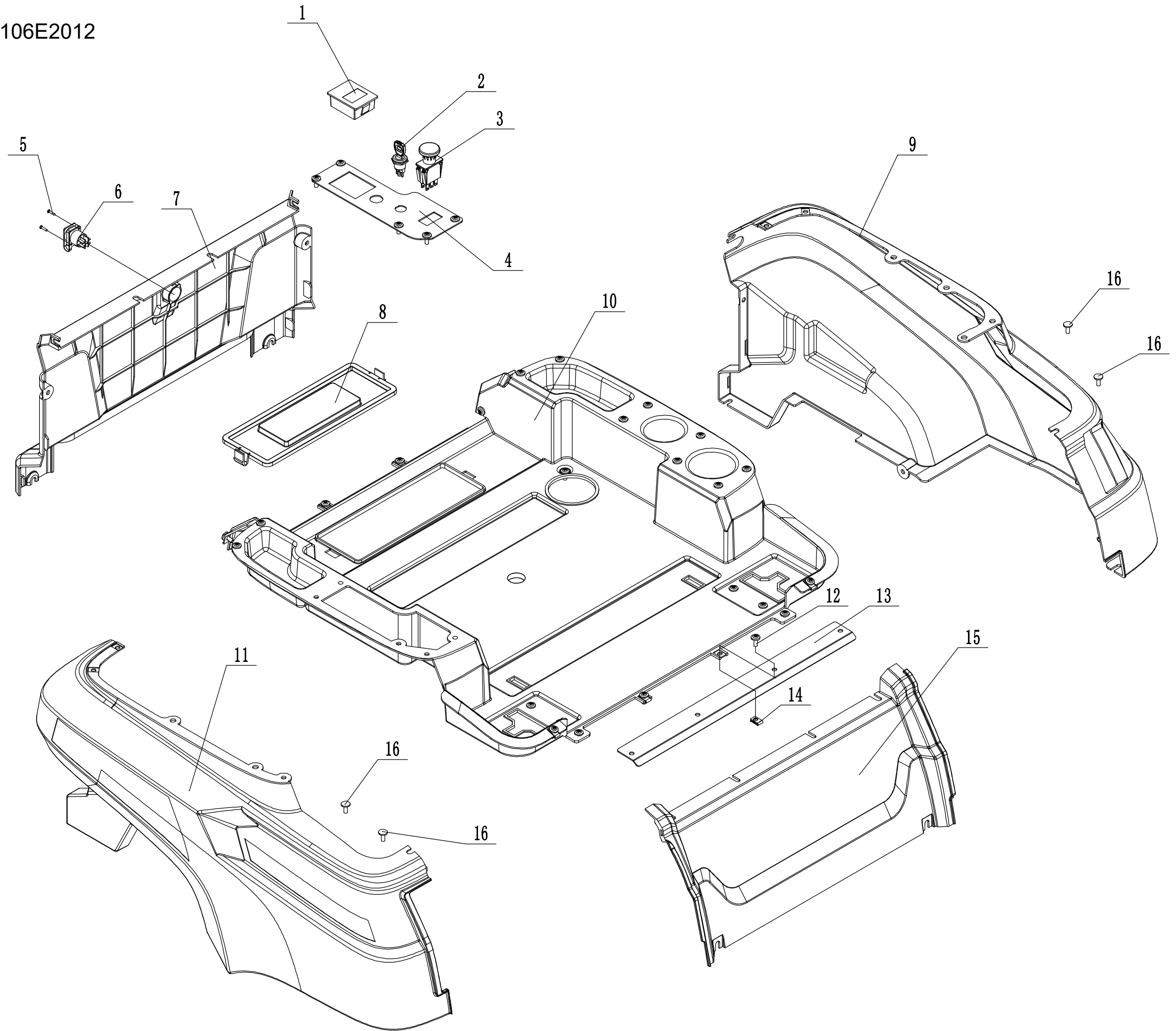

2	Ersatzteilliste WBZ 106 E 2025			
Nr.	Ersatzteilnummer	Bezeichnung Deutsch	Bezeichnung Englisch	Anzahl
1	Z42EB11000	Bildschirm	Display screen	1
2	76LDH002	Zündschloss	Key switch	1
3	Z61C0200	Messerschalter	Knife switch	1
4	Z42EB01000/22	Abdeckung	Control panel	1
5	0106003016	Schraube	Screw	2
6	16003631-01	Ladeanschluss	Power outlet	1
7	Z42EB02000	Hintere Abdeckung	Rear cover	1
8	Z42EB03000	Oberer Schutz	Upper guard cover	1
9	Z42EB04000	Abdeckung (links)	Left cover	1
10	Z42EB05000	Abdeckung (oben)	Upper cover	1
11	Z42EB06000	Abdeckung (rechts)	Right cover	1
12	0103006016/8P8	Schraube	Screw	52
13	Z42EB09000/22	Schiene	Shell layering	1
14	0218006000	Klammer	Nut - M6	15
15	Z42EB07000	Abdeckung (vorne)	Front cover	1
16	Z42EB10000	Propfen	Rivet	4

Model:WBZ106E  
Service code:WBZ106E2012  
Engine Part

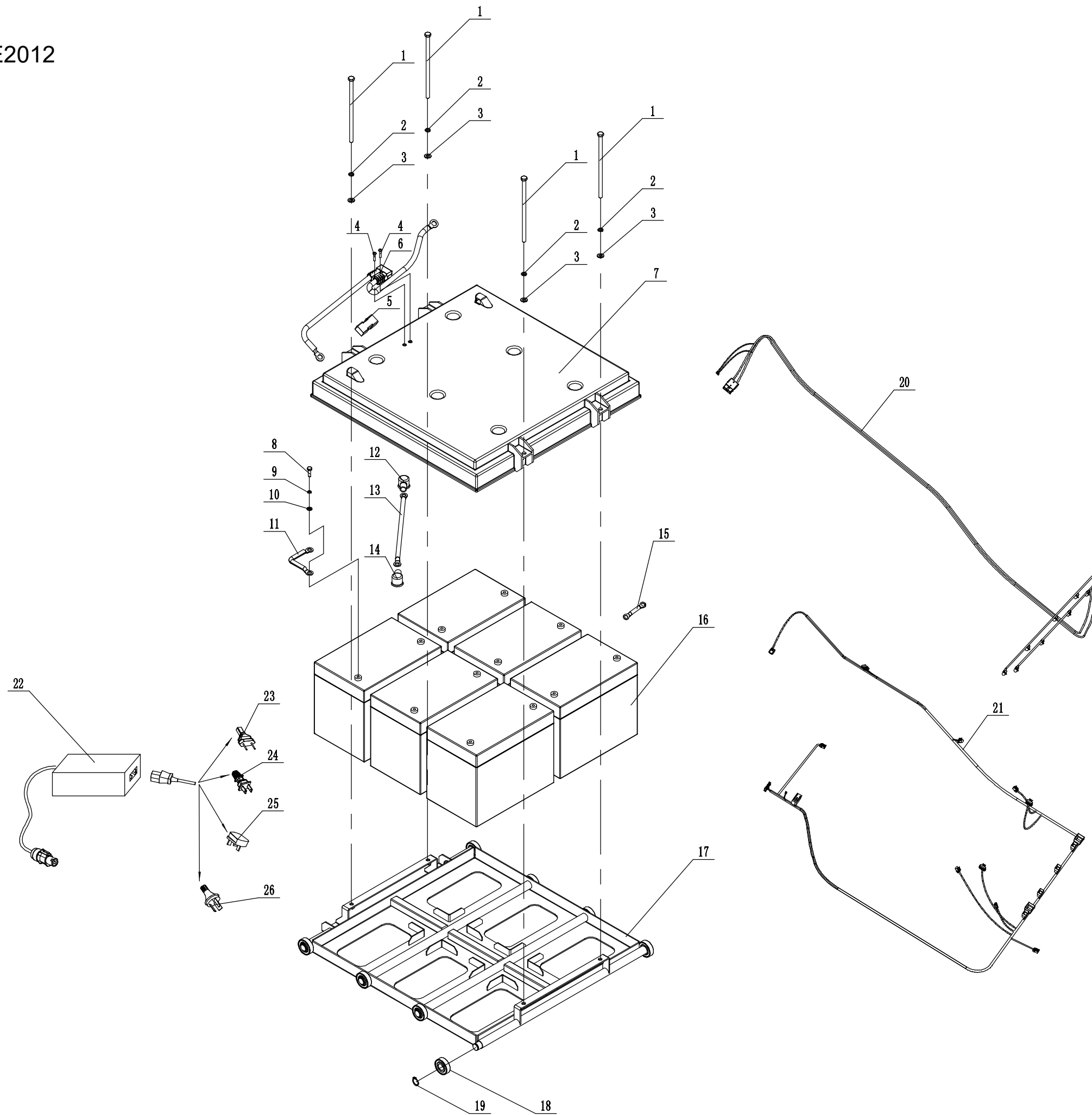

3	Ersatzteilliste WBZ 106 E 2025			
Nr.	Ersatzteilnummer	Bezeichnung Deutsch	Bezeichnung Englisch	Anzahl
1	0103008180	Bolzen	Bolt - M8x180	4
2	0401008000	Federscheibe	Spring Washer - 8x2.1	4
3	0301008000	Unterlegscheibe	Washer - 8x1.6	4
4	0104004020	Schraube	Screw	2
5	WB9681005	Sicherung	fuse	1
6	Z42EC13000	Verbindungsstecker	Connector	1
7	Z42EC01000	Batteriedeckel	Battery cover	1
8	0101006020	Schraube	Bolt - M6x20	12
9	0401006000	Scheibe	Spring Washer - 6x1.6	12
10	0301006000	Scheibe	Washer - 6x1.6	12
11	XS/Z42E0101	Kabel	Wire harness	1
12	WB9650008	Plus pol	Positive sheath	6
13	XS/Z42E0105	Kabel	Wire harness	4
14	WB9650007	Minus Pol	Negative sheath	6
15	XS/Z42E0104	Kabel	Wire harness	1
16	Z42EC09000	Batterie	Battery	6
17	Z42EC02000/22	Batterierhalterung	Battery tray	1
18	6203-2RS	Kugellager	Bearing	8
19	1001017000	Sicherungsring	Checkring	8
20	XS/Z42E0111	Kabelbaum	Wire harness	1
21	XS/Z42E0115	Kabelbaum	Wire harness	1
22	Z42EC03000	Ladegerät	Charger	1
23	Z42EC07000	Stecker (Europa)	European standard charging cable	1
24	Z42EC04000	-	American standard charging cable	1
25	Z42EC06000	-	British standard charging cable	1
26	Z42EC05000	-	Australian standard charging cable	1

Model:WBZ106E  
Service code:WBZ106E2012  
Left handle part

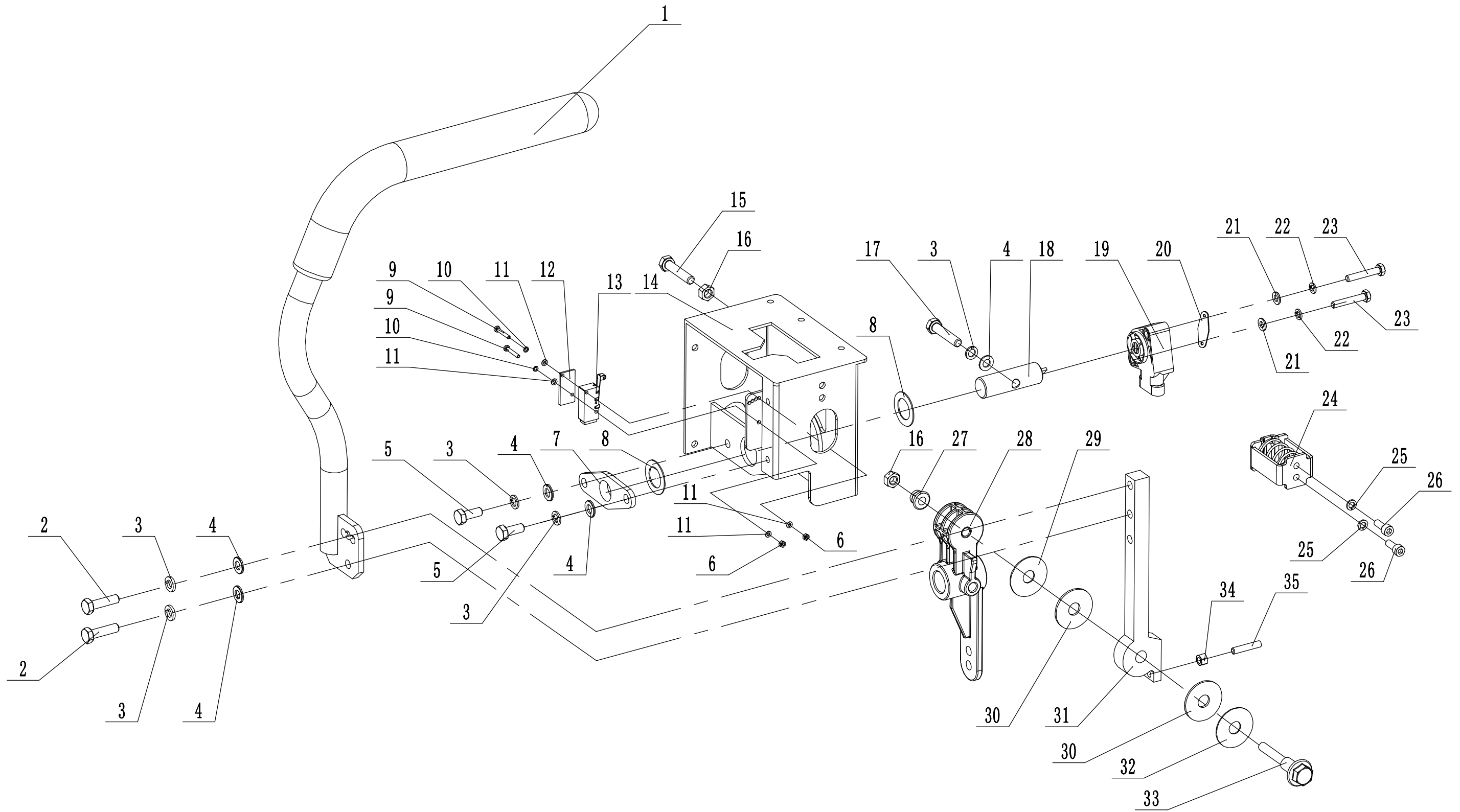

4	Ersatzteilliste WBZ 106 E 2025			
Nr.	Ersatzteilnummer	Bezeichnung Deutsch	Bezeichnung Englisch	Anzahl
1	Z42ED01000/22	Griff (links)	Left handle	1
2	0101008025	Bolzen	Bolt - M8x25	2
3	0403008000	Scheibe	Spring Washer - 8x2.4	5
4	0301008000	Unterlegscheibe	Washer - 8x1.6	5
5	0101008025	Bolzen	Bolt - M8x25	2
6	0201003000	Mutter	Nut - M3	2
7	Z42ED02000/01	Wellenpresser	Shaft presser	1
8	Z42ED03000	Ring	Damping pad	2
9	0104003020	Schraube	Screw - M3x20	2
10	0401003000	Scheibe	Spring Washer - 3x0.6	2
11	0301003000	Unterlegscheibe	Washer - 3x0.5	4
12	Z42ED14000/22	Platte	Pressure plate	1
13	Z42ED1600	Schalter	Switch	1
14	Z42ED04000/01	Gehäuse	Mounting plate	1
15	0101008055	Bolzen	Bolt - M8x55	1
16	0201008000	Mutter	Nut - M8	2
17	0101008055	Bolzen	Bolt - M8x55	1
18	Z42ED05000/06	Welle	Shaft	1
19	Z42ED15000	Elektronische Gasverstellung	Electronic throttle	1
20	Z42ED06000/01	Platte	Mounting plate	1
21	0301004000	Scheibe	Washer - 4x0.5	2
22	0401004000	Scheibe	Spring Washer - 4x1.1	4
23	0101005035	Schraube	Bolt - M5x35	2
24	Z42ED07000	Feder	Handle return	1
25	0401006000	Scheibe	Spring Washer - 6x1.3	2
26	0103006016	Bolzen	Bolt - M6x16	2
27	0210008000	Nuss	Lock Nut - M8	1
28	Z42ED08000	Griffhalter	Hinge	1
29	Z42ED09000	Gummidämpfer	Damping pad	1
30	Z42ED10000/02	Dichtung	Gasket	2
31	Z42ED11010/01	Halter	Connector	1
32	Z42ED12000/04	Unterlegscheibe	Dish Washer	1
33	Z42ED13000/04	Bolzen	Bolt	1
34	0201006000	Mutter	Nut - M6	1
35	0103006035	Bolzen	Bolt - M6x35	1



Model:WBZ106E  
Service code:WBZ106E2012  
Frame

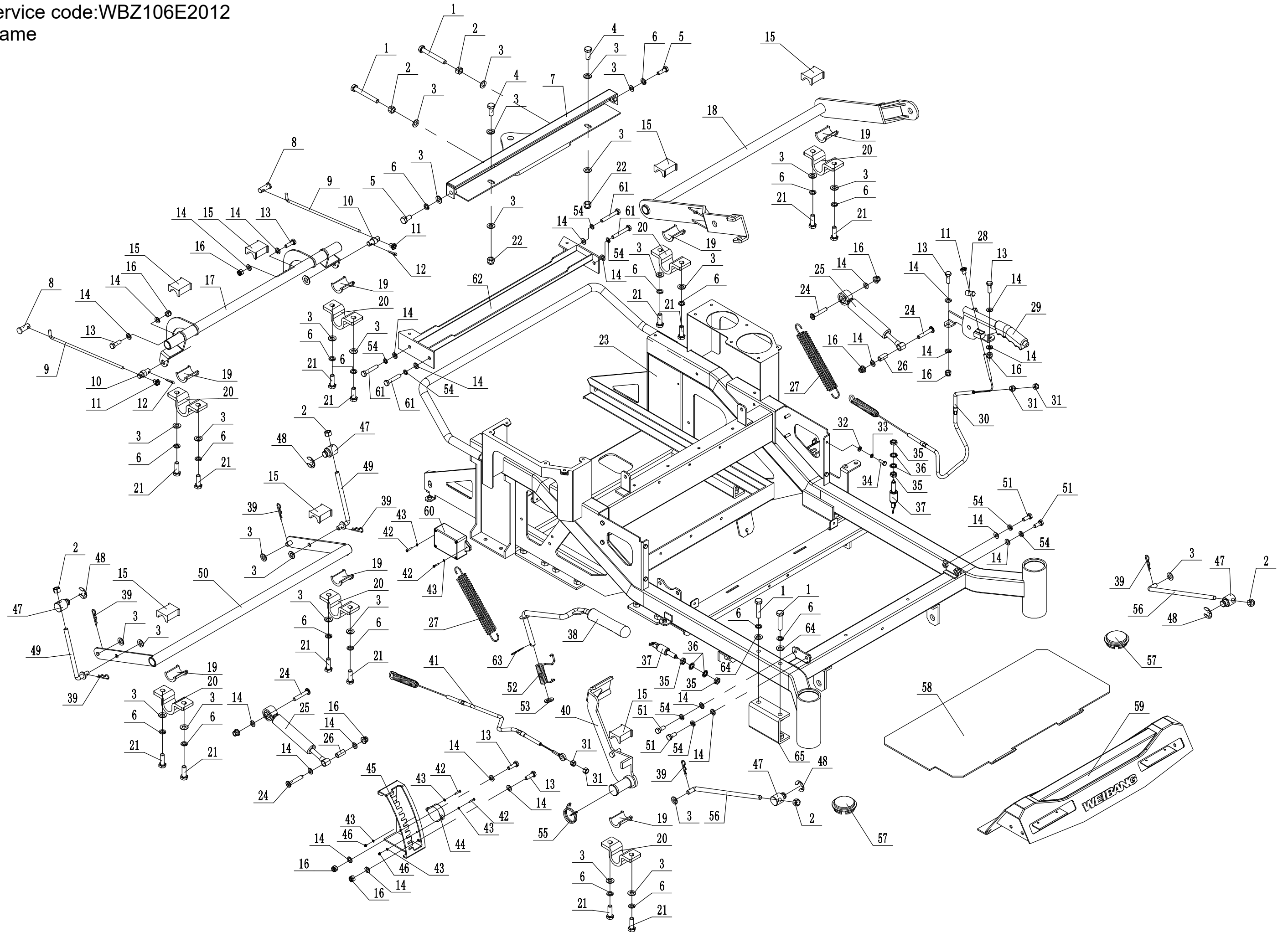

5	Ersatzteilliste WBZ 106 E 2025			
Nr.	Ersatzteilnummer	Bezeichnung Deutsch	Bezeichnung Englisch	Anzahl
1	0101010080	Bolzen	Bolt - M10x80	4
2	0201010000	Nuss	Nut - M10	6
3	0302010000	Scheibe	Washer - M10	26
4	0101010025	Schraube	Bolt - M10x25	2
5	0101010020	Bolzen	Bolt - M10x20	2
6	0401010000	Scheibe	Spring Washer - 10x2.6	18
7	Z42EE01000/22	Sitzplatte	Seal plate	1
8	Z42EE02000/01	Stift	Pin	2
9	Z42EE03000/01	Stange	Connecting Rod	2
10	Z42EE04000/01	Stift	Pin	2
11	76EH13010/02	Nuss	Nut	3
12	0501004018	Splint	Pin	2
13	0101008020	Bolzen	Bolt - M8x20	6
14	0301008000	Unterlegscheibe	Washer - 8x1.6	28
15	Z122320010	Nylon Schutz	Nylon Bush	7
16	0202008000	Sicherungsmutter	Lock Nut - M8	14
17	Z42EE05000/22	Stange	Shaft	1
18	Z42EE06000/22	Verbindungsstange	connecting rod	1
19	Z122319010	Nylon Schutz	Nylon Bush	7
20	Z42EE06070/49	Halterung	Steady	7
21	0101010035	Bolzen	Bolt - M10x35	14
22	0202010000	Sicherungsmutter	Lock Bolt - M10	2
23	Z42EE07000/49	Grundgestell	Frame	1
24	Z42EE08020	Bolzen	Bolt - M8x45	4
25	Z42EE08000	Stoßdämpfer	Damper	2
26	Z42EE08010	Buchse	Casing	2
27	Z42EE09000/02	Feder	Spring	2
28	76EH12010/02	Nuss	Shaft	1
29	Z42EE23000	Handbremse	Handle	1
30	Z42EE10000	Bremskabel	Brake cable	1
31	0201008000	Mutter	Bolt - M8	8
32	0301006000	Scheibe	Washer - 6x1.6	8
33	0401006000	Scheibe	Spring Washer - 6x1.6	8
34	0101006020	Schraube	Bolt - M6x20	8
35	0206010000	Mutter	Nut - M10	4
36	Z42EE24000	Scheibe	Washer	4
37	Z42EE32000	Schalter	Brake switch	2
38	Z42EE11000/22	Griff	Handle	1
39	Z42EE33000	Stift	Pin - 2.8x50	7
40	Z42EE12000/22	Pedal	Foot brake pedal	1
41	Z42EE13000	Bremskabel	Brake cable	1
42	0104003016	Stift	Screw - M3x16	4
43	0301003000	Unterlegscheibe	Washer - 3x0.5	4
44	Z42EE30000	Signalgeber	speaker	1

45	Z42EE14000/22	Höhenverstellsegment	Index plate	1
46	0202003000	Mutter	Lock Nut - M3	2
47	Z42EE15000/01	Halter	Pin	4
48	0501004032	Simmerring	E-Clip - M15	4
49	Z42EE16000/01	Stange	Pull hook	2
50	Z42EE17000/22	Verbindungsstange	connecting rod	1
51	0101008025	Bolzen	Bolt - M8x25	4
52	Z42EE18000/02	Feder	spring	1
53	03010012000	Unterlegscheibe	Washer - 12x2.5	1
54	0403008000	Scheibe	Spring Washer - 8x2.4	8
55	Z42EE19000/02	Feder	Spring	1
56	Z42EE20000/01	Stange	Hanging rod	2
57	10FS040601	Kappe	Dust cover	2
58	Z42EE21000/49	Fussablageblech	Pedal	1
59	Z42EE27000/49	Frontblech mit Logo	Pedal	1
60	Z42EE31000	Kasten	Power	1
61	0101008060	Bolzen	Bolt - M8x60	4
62	Z42EE25000/49	Halterung	Support beam	1
63	0501003020	Schließkeil	Pin - 3.2x20	1
64	0303010000	Scheibe	Washer - 10x2.5	4
65	Z42EE28000/49	Halter	Mounting seat	1

Model:WBZ106E  
Service code:WBZ106E2012  
Controller

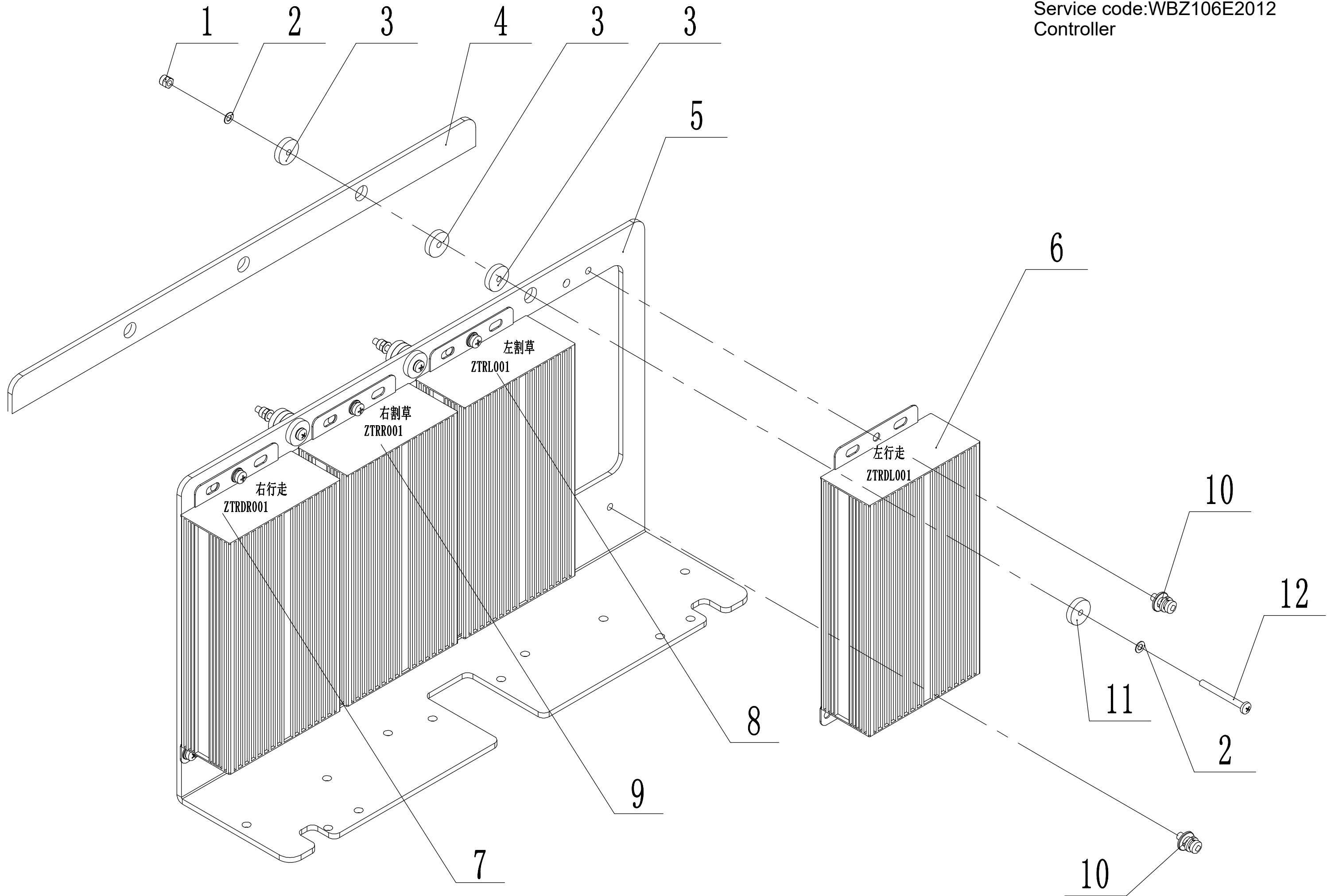

6	Ersatzteilliste WBZ 106 E 2025			
Nr.	Ersatzteilnummer	Bezeichnung Deutsch	Bezeichnung Englisch	Anzahl
1	0202004000	Mutter	Lock Nut - M4	6
2	0301004000	Scheibe	Washer - 4x0.5	12
3	76ED06010	Scheibe	Insulation pad	18
4	Z42EF02000/22	Polster	Pad	1
5	Z42EF01010/22	Halterung	Mounting plate	1
6	Z42EF03010	Steuergerät Antrieb (links)	Left walk controller	1
7	Z42EF03020	Steuergerät Antrieb (rechts)	Right walk controller	1
8	Z42EF03030	Steuergerät Messer (links)	Left mowing controller	1
9	Z42EF03040	Steuergerät Messer (rechts)	Right mowing controller	1
10	0126005012	Schraube	Screw - M5x12	8
11	76ED05010	Scheibe	Septum	6
12	0104004040	Schraube	Screw - M4x40	6

Model:WBZ106E  
Service code:WBZ106E2012  
Right handle part

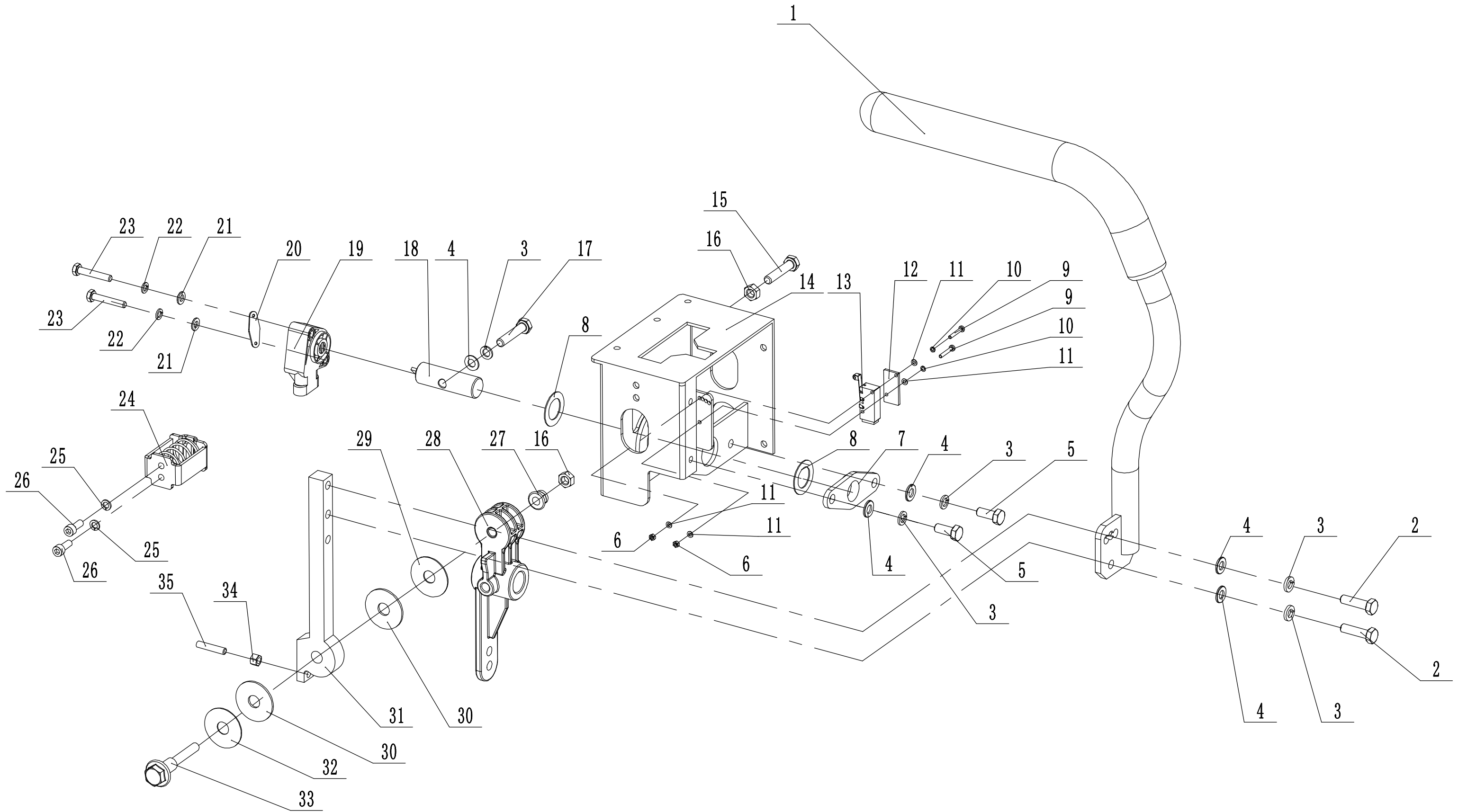

7	Ersatzteilliste WBZ 106 E 2025			
Nr.	Ersatzteilnummer	Bezeichnung Deutsch	Bezeichnung Englisch	Anzahl
1	Z42EG01000/22	Griff (rechts)	Right handle	1
2	0101008025	Bolzen	Bolt - M8x25	2
3	0403008000	Scheibe	Spring Washer - 8x2.4	5
4	0301008000	Unterlegscheibe	Washer - 8x1.6	5
5	0101008025	Bolzen	Bolt - M8x25	2
6	0201003000	Mutter	Nut - M3	2
7	Z42EG02000/01	Platte	Pressure plate	1
8	Z42ED03000	Ring	Damping pad	2
9	0104003020	Schraube	Screw - M3x20	2
10	0401003000	Scheibe	Spring Washer - 3x0.6	2
11	0301003000	Unterlegscheibe	Washer - 3x0.5	4
12	Z42ED14000/02	Platte	Pressure plate	1
13	Z42ED1600	Schalter	Switch	1
14	Z42EG04000/01	Gehäuse	Mounting plate	1
15	0101008055	Bolzen	Bolt - M8x55	1
16	0201008000	Mutter	Nut - M8	2
17	0101008055	Bolzen	Bolt - M8x55	1
18	Z42EG05000/06	Welle	Shaft	1
19	Z42ED15000	Elektronische Gasverstellung	Electronic throttle	1
20	Z42EG06000/01	Platte	Mounting plate	1
21	0301004000	Scheibe	Washer - 4x0.5	2
22	0401004000	Scheibe	Spring Washer - 4x1.1	2
23	0101005035	Schraube	Bolt - M5x35	2
24	Z42EG07000	Feder	Handle return	1
25	0401006000	Scheibe	Spring Washer - 6x1.3	2
26	0101006016	Schraube	Bolt - M6x16	2
27	0210008000	Nuss	Lock Nut - M8	1
28	Z42ED08000	Griffhalter	Hinge	1
29	Z42ED09000	Gummidämpfer	Damping pad	1
30	Z42EG10000/01	Scheibe	Gasket	2
31	Z42ED11020/01	Halter	Connector	1
32	Z42EG12000/04	Scheibe	Dish Washer	1
33	Z42EG13000/04	Bolzen	Bolt	1
34	0201006000	Mutter	Nut - M6	1
35	0103006035	Bolzen	Bolt - M6x35	1

Model:WBZ106E  
Service code:WBZ106E2012  
Rear Wheel

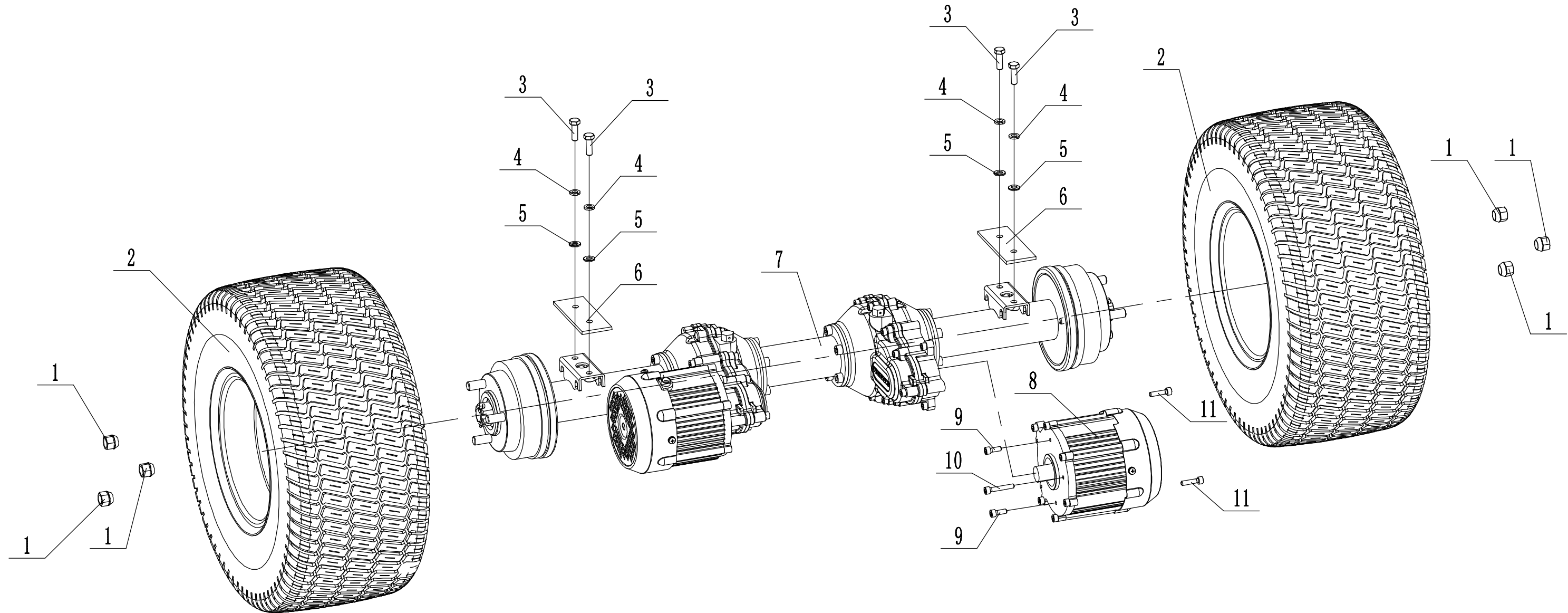



8	Ersatzteilliste WBZ 106 E 2025			
Nr.	Ersatzteilnummer	Bezeichnung Deutsch	Bezeichnung Englisch	Anzahl
1	0215012000	Mutter	Nut - M12	6
2	Z42EH01000	Hinterrad	Rear wheel	2
3	0101008035	Bolzen	Bolt - M8x35	4
4	0403008000	Scheibe	Spring Washer - 8x2.4	4
5	0301008000	Unterlegscheibe	Washer - 8x1.6	4
6	Z42EE26000/22	Platte	pad	2
7	Z42EH02000	Getriebe	Rear Transmission Assembly	1
8	WB9250007	Elektromotor	Motor	2
9	0103006025	Bolzen	Screw - M6*25	4
10	0103006080	Schraube	Screw - M6*80	2
11	0103006040	Schraube	Screw - M6*40	4

Model:WBZ106E  
Service code:WBZ106E2012  
Front wheel

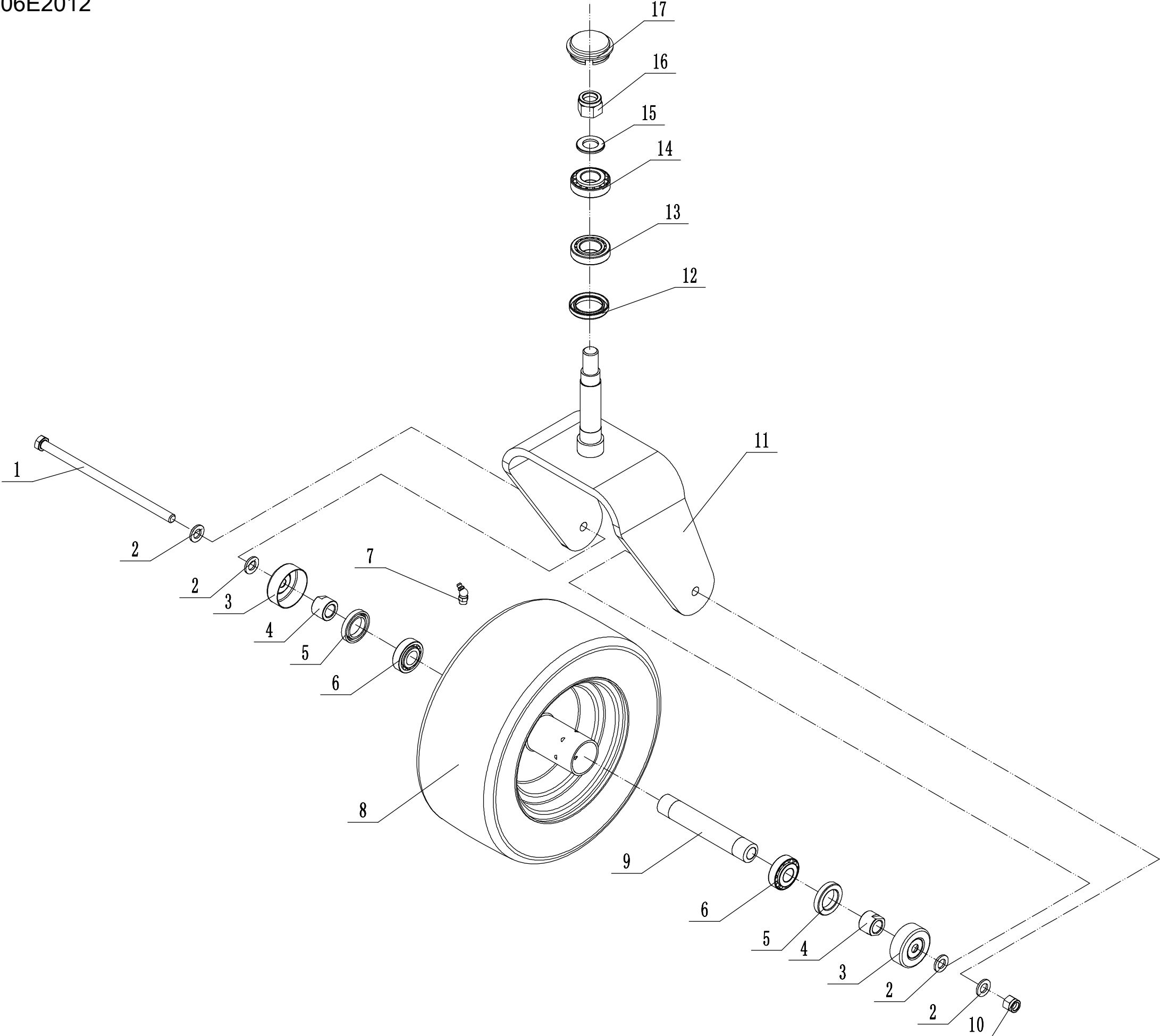

9	Ersatzteilliste WBZ 106 E 2025			
Nr.	Ersatzteilnummer	Bezeichnung Deutsch	Bezeichnung Englisch	Anzahl
1	0101012180	Bolzen	Bolt - M12x180	2
2	0301012000	U-Scheibe	Washer - $\phi$ 12	8
3	Z6190300/02	Schutz	Sheath of wheel	4
4	Z485020000/02	Buchse	Cap	4
5	Z6190700	Dichtung	Oil seal	4
6	LM11949-10	Kugellager	Bearing	4
7	2501008001A	Abschmiernippel	zerk M8x1	2
8	Z48LZ011	Vorderrad	Front wheel	2
9	Z485030000/02	Welle	Inner shaft sheath of front wheel	2
10	0202012000	Kontermutter	Lock Nut - M12	2
11	Z122302010/49	Radhalter	Front wheel bracket	2
12	01505203506	Dichtring	Seal ring	2
13	320-28	Lager	Bearing	1
14	30205	Lager	Bearing	1
15	0301020000	Unterlegscheibe	Washer	2
16	0202020000	Mutter	Lock nut - M20	2
17	10FS040601	Kappe	Cap	2

Model:WBZ106E  
Service code:WBZ106E2012  
Blade disc

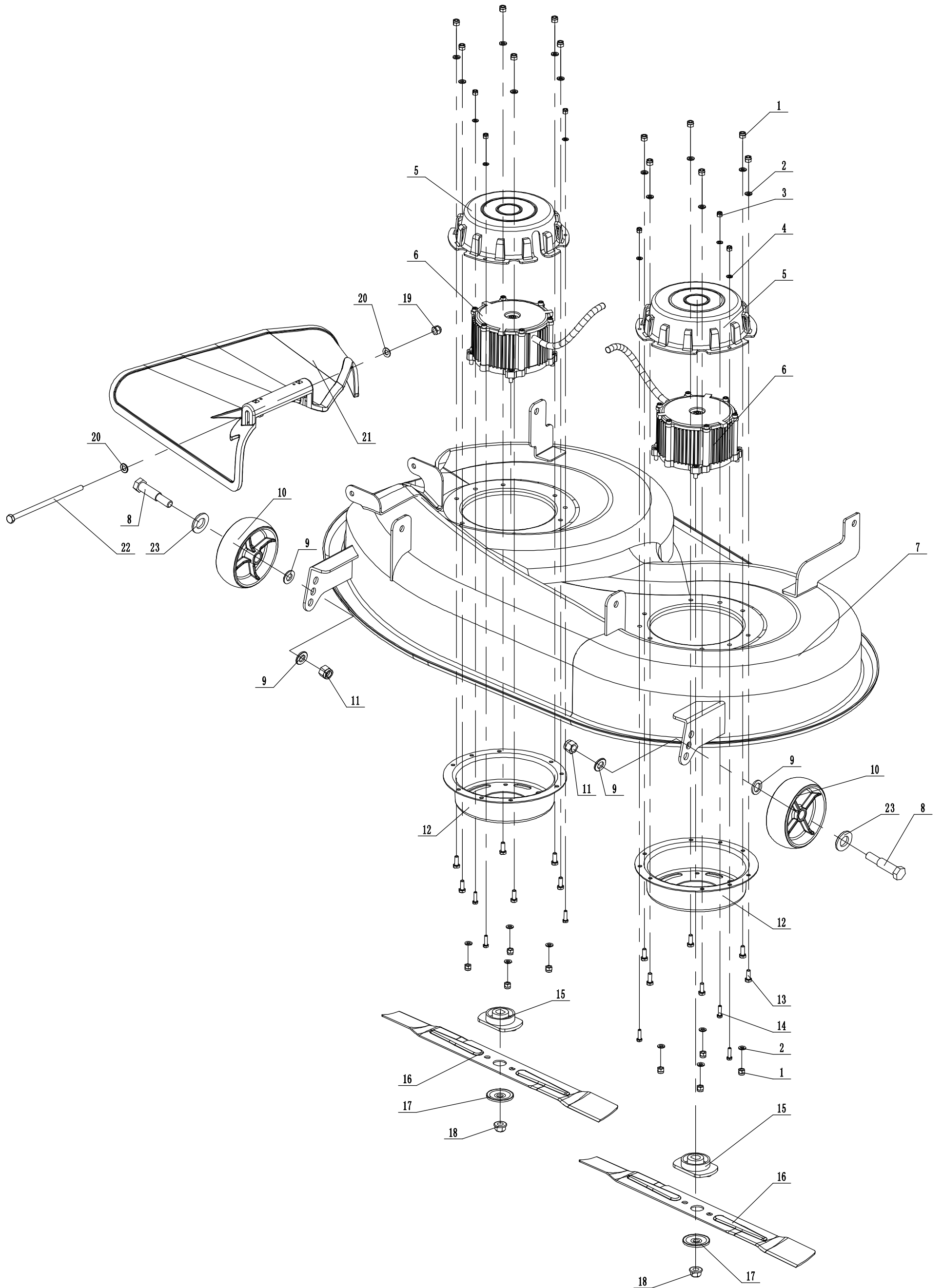

10 Ersatzteilliste WBZ 106 E 2025				
Nr.	Ersatzteilnummer	Bezeichnung Deutsch	Bezeichnung Englisch	Anzahl
1	0202006000	Sechskant Sicherungsmutter	Lock Nut - M6	20
2	0301006000	Scheibe	Washer - 6x1.6	20
3	0202005000	Sicherungsmutter	Lock Nut - M5	6
4	0301005000	Unterlegscheibe	Washer - 5x1.6	6
5	Z42EK01000	Schutz	Engine cover	2
6	WB9250008	Elektromotor	Engine	2
7	Z42EK02000/22	Mähwerk	Blade Disc	1
8	Z42EK03000/01	Bolzen	Wheel shaft	2
9	0301012000	U-Scheibe	Washer - 12x2.5	4
10	Z42EK04000	Rad	Scroll wheel	2
11	0202012000	Kontermutter	Lock Nut - M12	2
12	76EF11010/34	Motorhalter	Engine base	2
13	0101006016	Schraube	Bolt - M6x16	12
14	0101005016	Bolzen	Bolt - M5x16	6
15	76EF12010	Messerhalter	Adapter	2
16	Z42EK05000/32	Messer	Blade	2
17	5310406010/04	Scheibe	Dish Washer	2
18	0203010000	Mutter	Lock Nut - M10	2
19	0202008000	Sicherungsmutter	Lock Nut - M8	1
20	0301008000	Unterlegscheibe	Washer - 8x1.6	2
21	Z42EK06000	Seitenauswurfklappe	Deflector	1
22	0101008170	Bolzen	Bolt - M8x170	1
23	Z42EK09000/02	Scheibe	Washer	2
24	Z42EK08000	Verschlussklappe (Mähwerk)		1