

# 2 Main Body

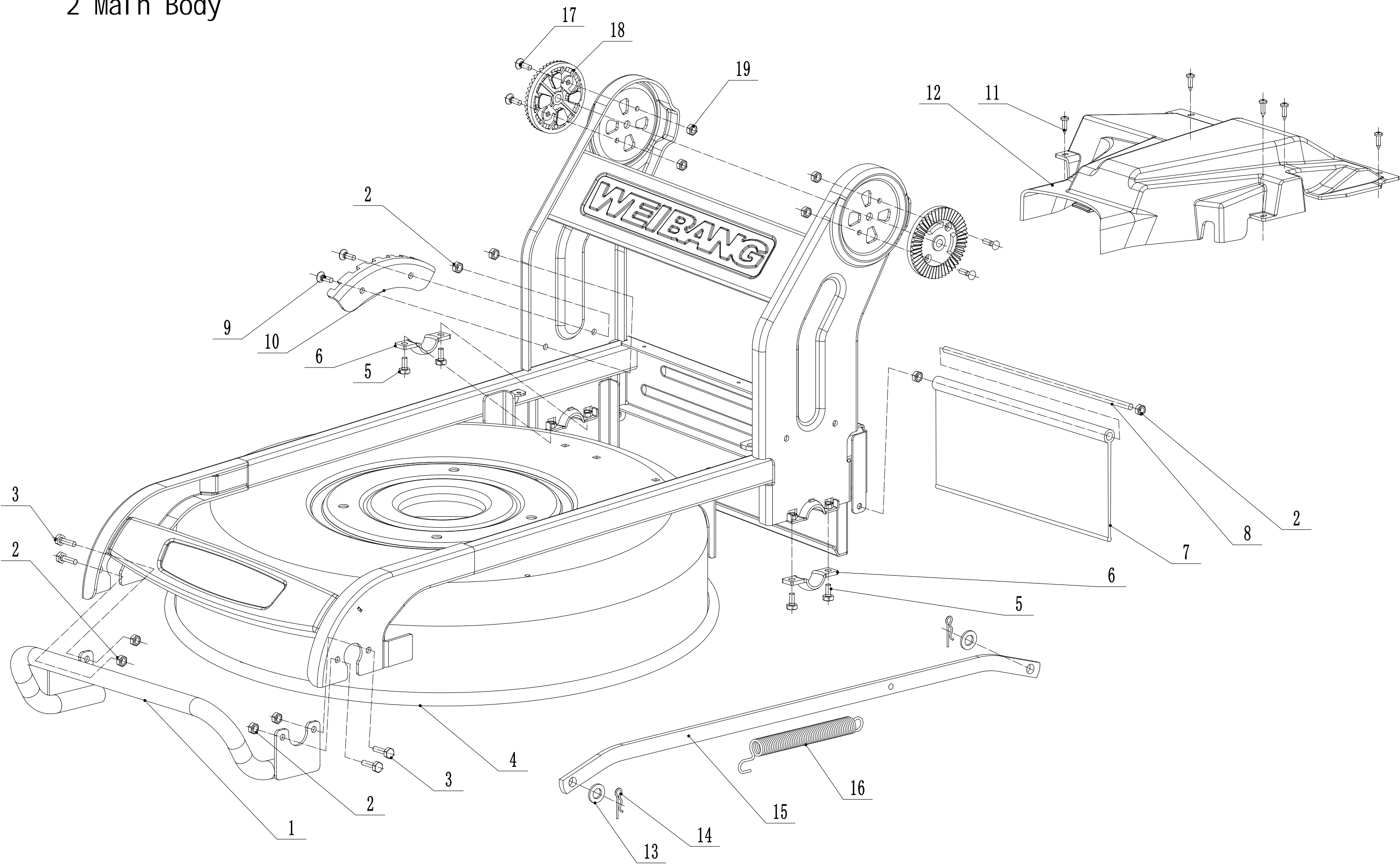

2	Ersatzteilliste WB 537 SC M 2025			
Nr.	Ersatzteilnummer	Bezeichnung Deutsch	Bezeichnung Englisch	Anzahl
1	GM53A040000000/40	Stoßstange	Bumper	1
2	0202006000	Sechskant Sicherungsmutter	Lock Nut - M6	8
3	0102006018	Bolzen	Bolt - M6x18	4
4	GM53F010000000B1/49	Gehäuse	Chassis	1
5	0102006012	Bolzen	Bolt - M6x12	4
6	5320114020/01	Halter	Bearing Holder	2
7	GM53A000000080	Gummilippe	Trailing Flap	1
8	4510112020/02	Stange	Rod - Trailing Flap	1
9	0104006016	Schraube	Screw - M6x16	2
10	GM53A000000030/01	Höheneinstellung	Graduator	1
11	0106004010	Schraube	Screw - ST4.2x10	5
12	GM53A000000020	Riemenschutz	Rear Shield	1
13	0301010000	Scheibe	Washer - M10	2
14	5320333010	Federsplint	Check Ring	2
15	GM53A000000040/40	Verbindungsstange	Connecting Rod	1
16	GM53F000000010/01	Feder	Spring - Connecting Rod	1
17	0104005012	Schraube	Screw - M5x12	4
18	AVSA000000040/22	Schnellverschluß (Holm)	Tooth Disc	2
19	0202005000	Sicherungsmutter	Lock Nut - M5	4

3 Blade system

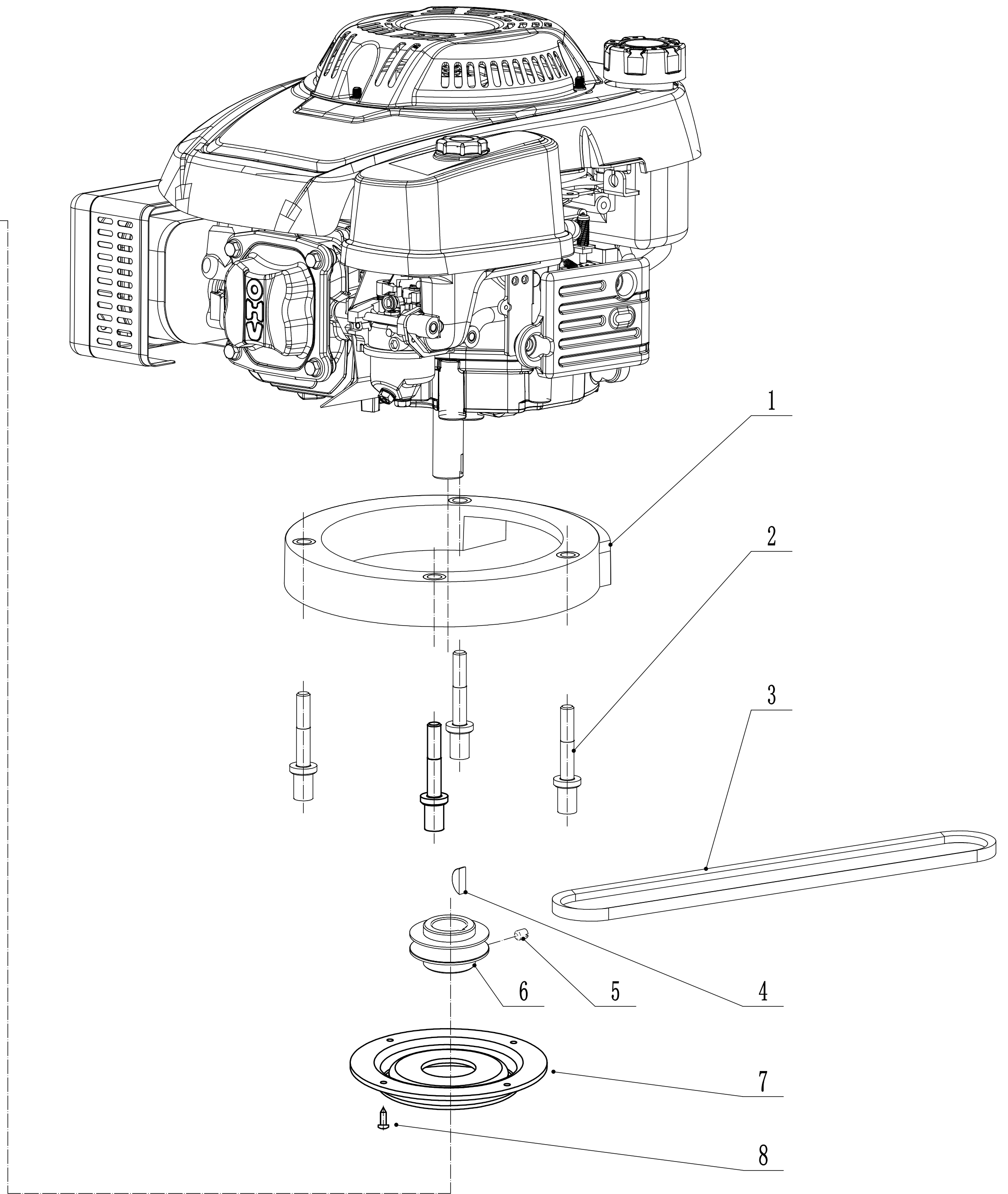
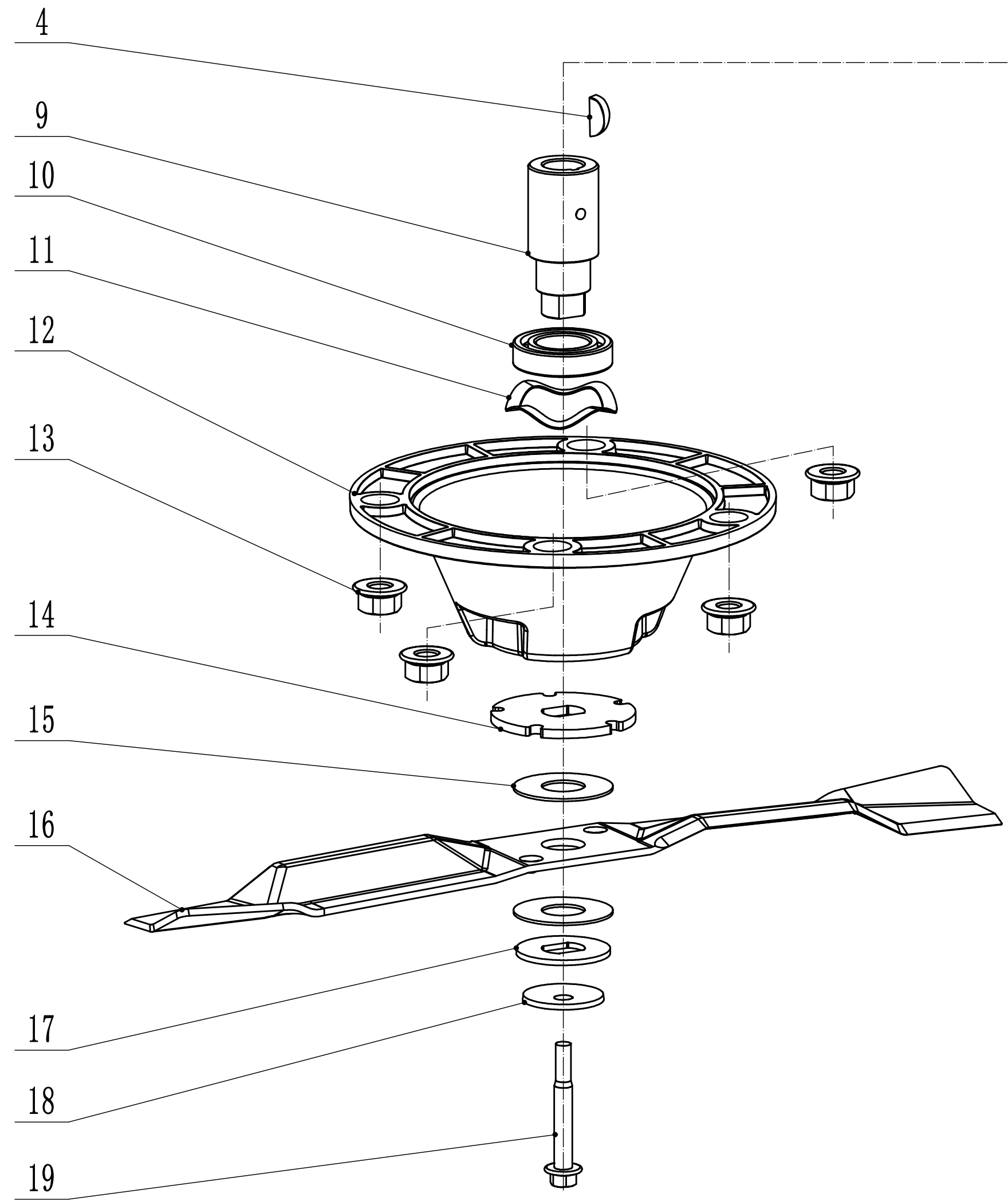

3	Ersatzteilliste WB 537 SC M 2025			
Nr.	Ersatzteilnummer	Bezeichnung Deutsch	Bezeichnung Englisch	Anzahl
1	GM53A050000000	Motorhalterung	Engine Base	1
2	GM53A000000070/02	Bolzen	Bolt	4
3	VB53M10/845	Keilriemen	Belt - V10x805	1
4	4510401010	Keil	Key	2
5	0105006006	Lochschraube	Screw - M6x6	1
6	5020402070/02	Riemenscheibe	Pulley	1
7	GM53F000000080	Staubschutz	Dust cover	1
8	0106004013	Schraube	screw	4
9	GM53F000000070/02	Messerhalter	Adaptor	1
10	6006/2RS	Lager	Bearing	1
11	GM53A000000120	Federscheibe	Spring Washer	1
12	GM53A000000010	Spindelhalterung	Axle Protection Bracket	1
13	0204014000	Sicherungsmutter	Lock Nut - M14	4
14	GM53F000000040/04	Abstandshalter	Spacer	1
15	GM53F000000050	Friktionscheibe	friction plate	2
16	GM53F000000030/32	Mulchmesser	Blade	1
17	GM53F000000060/04	Scheibe	Washer	1
18	5310406010/04	Scheibe	Spring Washer	1
19	GM53F000000090	Messerbolzen	Blade Bolt	1

# 4 Front Axle

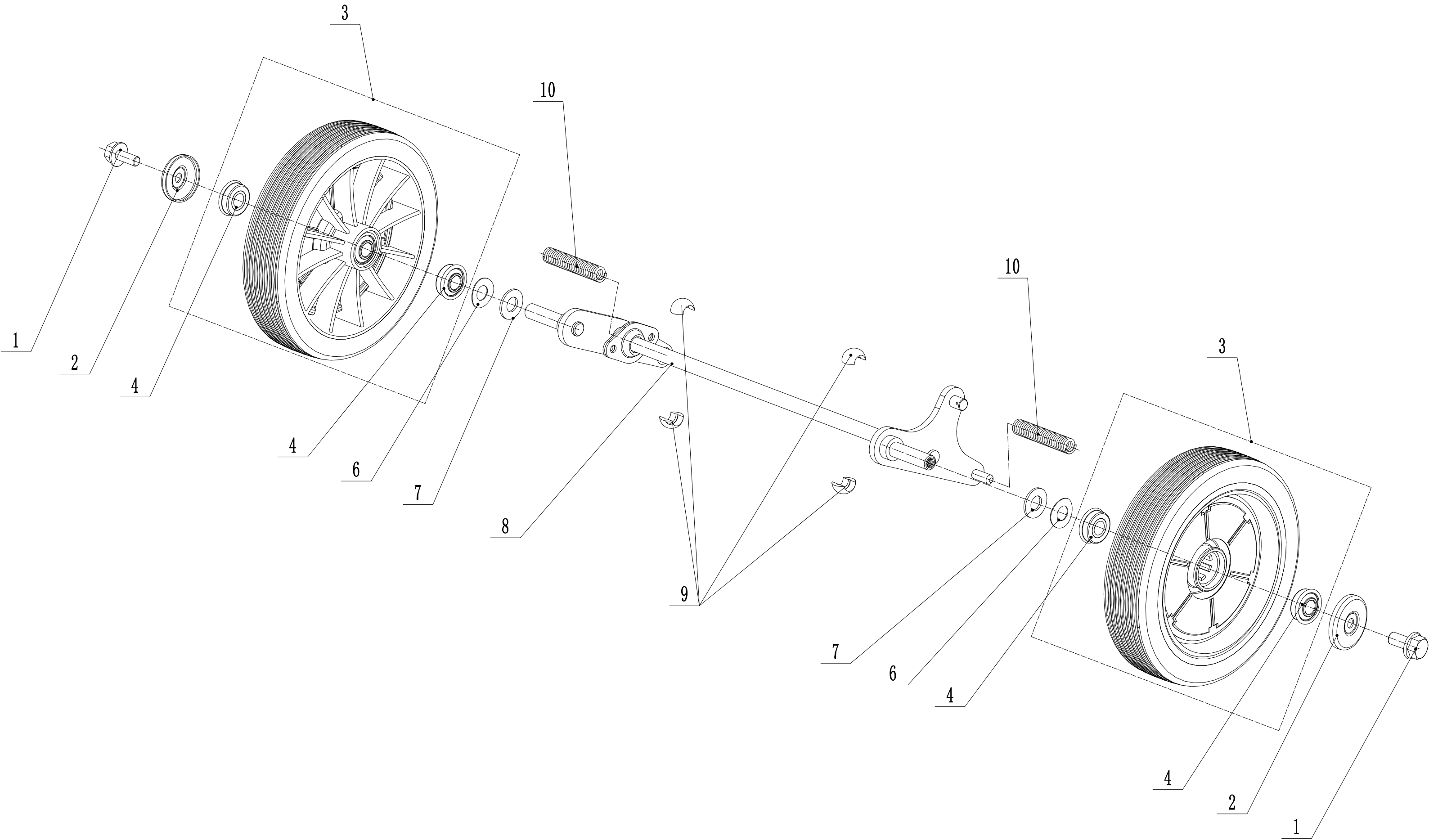

4	Ersatzteilliste WB 537 SC M 2025			
Nr.	Ersatzteilnummer	Bezeichnung Deutsch	Bezeichnung Englisch	Anzahl
1	0102008016	Bolzen	Bolt - M8x16	2
2	5380207010	Radkappe (neue Alu-Räder)	Wheel Cap	2
3	5380205010/40	ALU Rad	8" AL Wheel	2
4	5310213010	Lager	Bearing	4
6	5310211010/02	Federscheibe	Spring Washer	2
7	5310210010/02	Scheibe	Spacer	2
8	GM53F020100000/01	Vorderachse	Front Axle	1
9	5310209010	Lager	Spherical Bearing	4
10	GM53A020000010	Feder	Scraper	2

# 5 Rear Axle

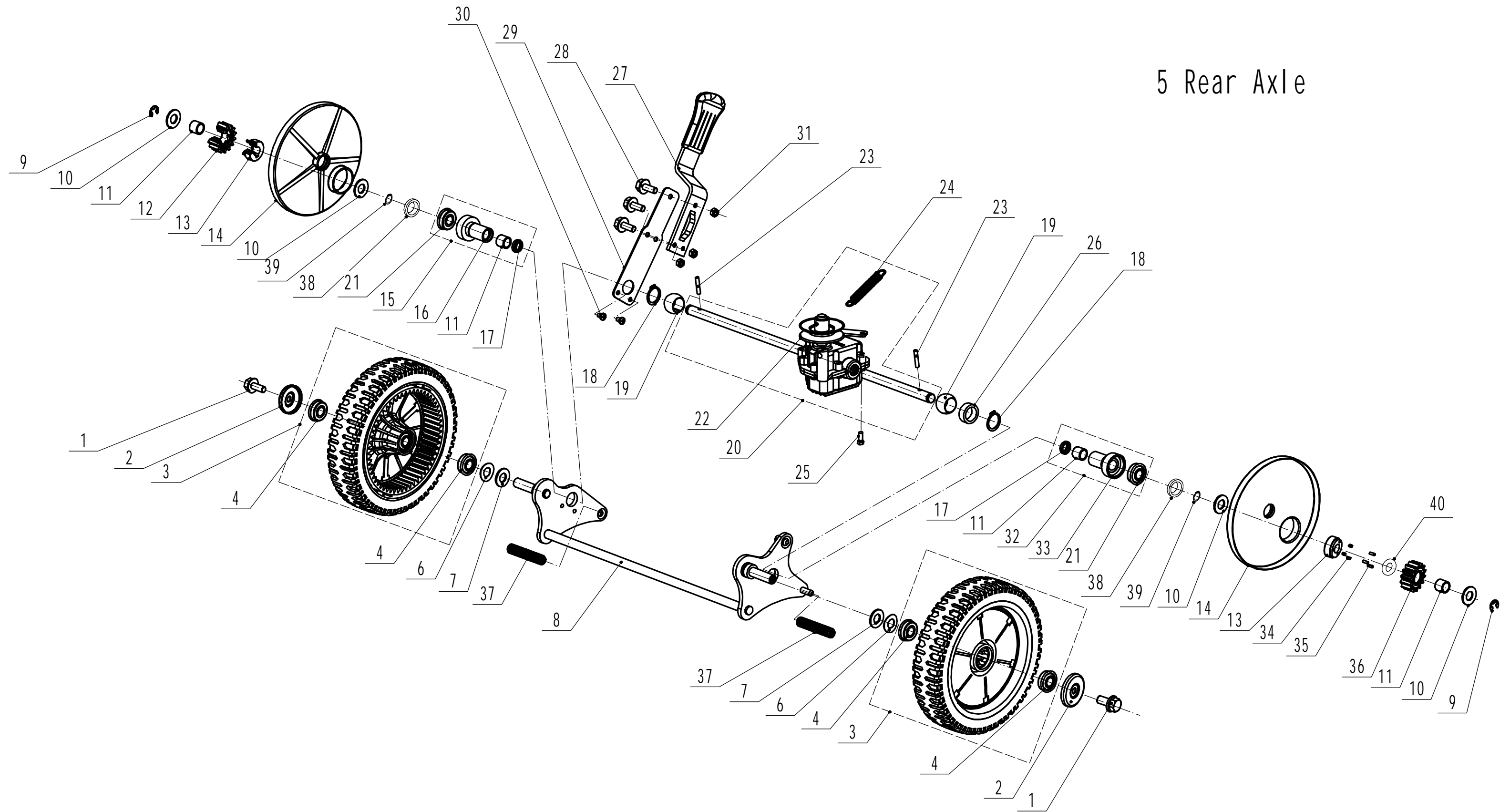

5	Ersatzteilliste WB 537 SC M 2025			
Nr.	Ersatzteilnummer	Bezeichnung Deutsch	Bezeichnung Englisch	Anzahl
1	0102008016	Bolzen	Bolt - M8x16	2
2	5380207010	Radkappe (neue Alu-Räder)	Wheel Cap	2
3	5380310010/40	Hinterrad	Al wheel- 9"	2
4	5310213010	Lager	Bearing	6
6	5310211010/02	Federscheibe	Spacer	2
7	5310210010/02	Scheibe	Washer	2
8	GM53F030100000/01	Hinterachse	Rear Axle	1
9	1301009000	Sicherungsring	E-Clip - M9	2
10	5020311010/04	Scheibe	Spacer	4
11	5320326010P	Buchse	Bearing	4
12	HQ000100020	Zahnrad (rechts)	Drive Pinion - R/H	1
13	HQ000100050	Halter	Ratchet	2
14	5340310020	Staubschutz	Dustproof Shield	2
15	Y065321	Lager	Right Bearing Sheath Assembly	1
16	5320325020/02	Lager	Right Bearing Sheath	1
17	5320327010	Staubabdeckung	Dustproof Ring	2
18	1001020000	Sicherungsring für Welle	Check Ring - M20	2
19	5320328010	Nylon Lager	Spherical Bearing	2
20	Y20536M	Getriebe	Transmission Assembly	1
21	R8-2RS	Kugellager	Bearing	2
22	4540318010	Rolle	Gearbox Pulley	1
23	HQ000100060	Stift	Pin For Ratchet	2
24	4820317010	Getriebefeder	Gearbox Sping	1
25	0101006020	Schraube	Hex Head Bolt - M6x20	2
26	5020310010/02	Buchse	Rear Transmission Partition	1
27	5360310010/40	Höhenverstellhebel	Adjustment Lever	1
28	0101006014	Bolzen M6x14	Bolt - M6x14	3
29	5360311010/22	Halter	Spring Of Adjustment Lever	1
30	0113005008	Schraube M5x8	Screw - M5x8	2
31	02020060000	Sicherungsmutter	Lock Nut - M6	3
32	Y065320	Lager	Left Bearing Sheath Assembly	1
33	5320324020/02	Hülse	Right Bearing Sheath	1
34	HQ000100040	Feder	Spring - Drive Pinion	6
35	HQ000100030	Stift	Pin - Drive Pinion	6
36	HQ000100010	Zahnrad (links)	Drive Pinion - L/H	1
37	GM53A020000010	Feder	Scraper	2
38	GM48S010000010	Ring	Spacer	2
39	1001012000	Ring	Circlip - M12	2
40	1401025015	Ring	O-ring	2



# 6 Handle And Controls

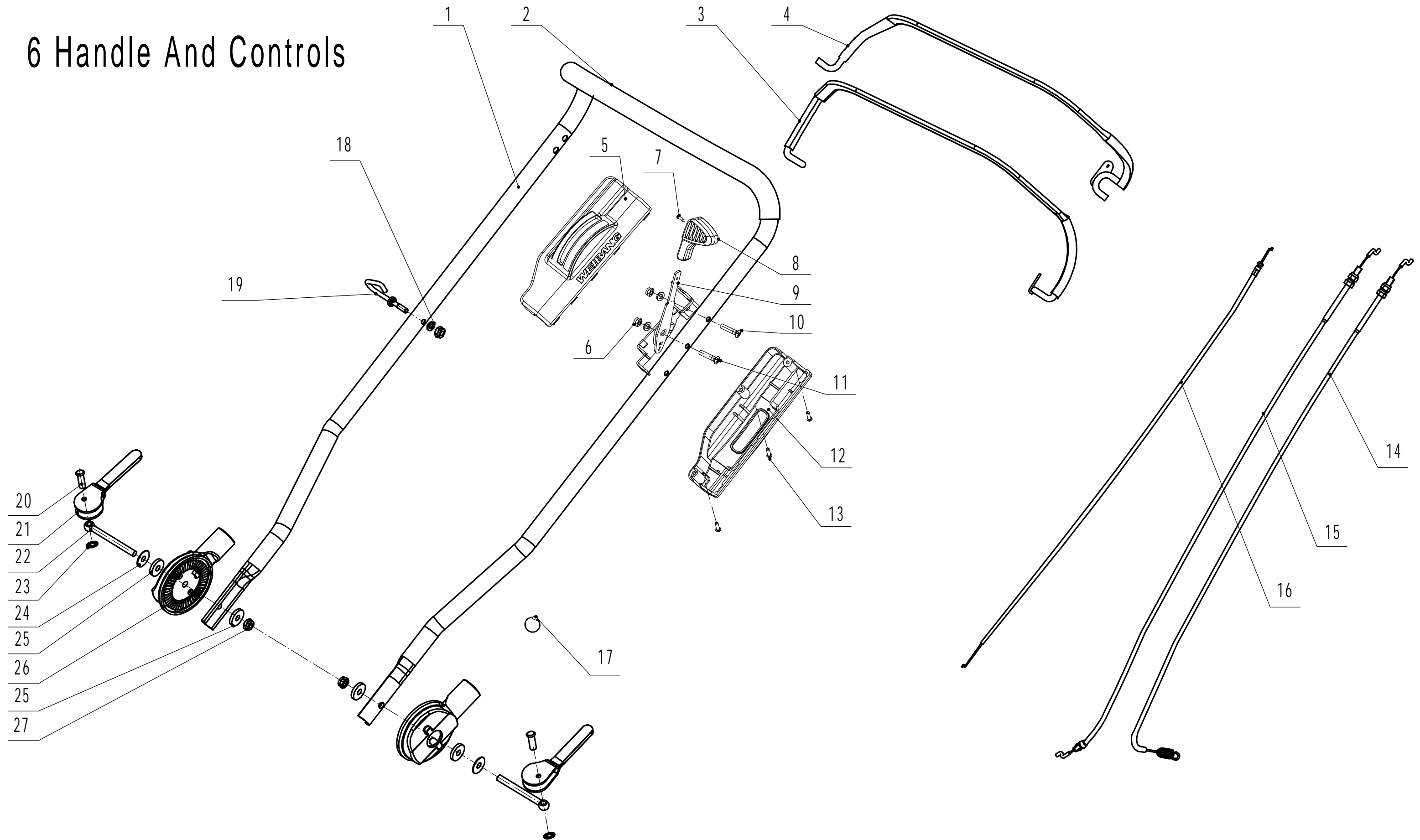

6	Ersatzteilliste			WB 537 SC M	2025
Nr.	Ersatzteilnummer	Bezeichnung Deutsch	Bezeichnung Englisch	Anzahl	
1	GM53F090000010/49	Holm	Handle	1	
2	GM56E010000082	Griffschutz	Handle Sheath	1	
3	5320511030S/40	Kupplungshebel	Clutch Lever	1	
4	5320503020S/40	Hebel	OPC Lever	1	
5	GM46E050000030	Kabelbox obere Hälfte	Throttle Control Box Upper Cover	1	
6	0202006000	Sechskant Sicherungsmutter	Lock Nut - M6	3	
7	0106003013	Schraube	Screw - ST2.9x13	1	
8	5380510010	Kappe für Gasgriff	Throttle Control Grip	1	
9	GM46E050100000	Gashebel	Throttle Control Bracket	1	
10	0108006040	Schraube	Screw - M6x40	1	
11	0108006050	Schraube	Screw - M6x50	1	
12	GM46E050000040	Kabelbox untere Hälfte	Throttle Control Box Lower Cover	1	
13	0113040018	Schraube	Screw - ST4x18	3	
14	LH189-1360	Kupplungskabel	Clutch Cable	1	
15	BS120-1140	Motorbremszug	Brake Cable	1	
16	YM72-1115-A	Gaszug	Throttle Cable	1	
17	ZD8/200	Kabelbinder	Cable tie	3	
18	0301006000	Scheibe	Washer - M6	3	
19	4510511010/01	Kabelhalter	Hook - Starter Rope	1	
20	0801008025	Stift	Axis Pin - 8x25	2	
21	GM56A100400000	Hebel	Lock Lever	2	
22	GM48S000000100	Bolzen	Connecting Bolt	2	
23	4510114030	Buchse	Fix Cap	2	
24	GM56A100000040/04	Scheibe	Spacer	2	
25	GM56A100000050/02	Schreibe	Spacer	4	
26	GM48S030200000	Verstellsegment	Tooth Disc Kit	2	
27	0203008000	Mutter	Lock Nut-M8	2	