

Model:WB486SC AL
Service Code:W486SC100B2011
Main Body

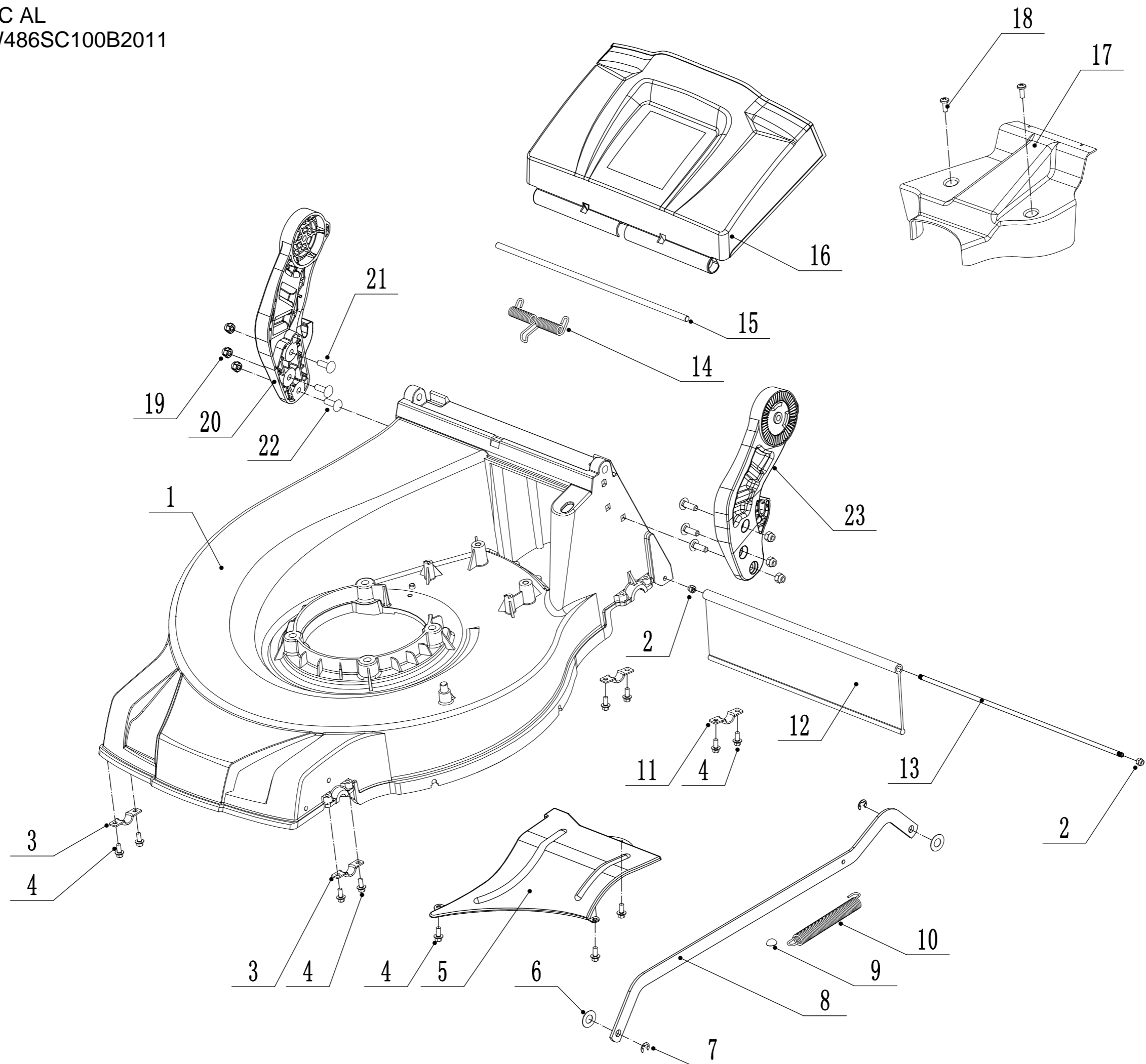

2	Ersatzteilliste WB 486 SC AL 2025			
Nr.	Ersatzteilnummer	Bezeichnung Deutsch	Bezeichnung Englisch	Anzahl
1	4860101010/49	Gehäuse	Chassis	1
2	0202006000	Sechskant Sicherungsmutter	Lock Nut - M6	17
3	4820208010/01	Klammer	Front Bearing Bracket	2
4	4820104010	Schraube	Screw - M6x12	11
5	4820103010/49	Umlenklech	Lower Baffle	1
6	4820306013	Nylon Scheibe	Nylon Mat	2
7	1301008000	Sicherungsring	E-Clip - 8mm	2
8	4860304010/40	Verbindungsstange	Connecting Rod	1
9	4820307011	Sicherrungsring	Domed Grip Washer	1
10	4820307010/01	Feder	Spring - Connecting Rod	1
11	5320114020/01	Halter	Upper Bearing Bracket	2
12	4510111030	Schutz	Trailing Flap	1
13	5020117010/02	Stange	Pivot - Trailing Flap	1
14	4860106010	Feder	Spring - Rear Cover	1
15	4860105010/01	Stange	Pivot - Rear Cover	1
16	4860104010	Abdeckung	Rear Cover	1
17	4860103010	Abdeckung	Upper Belt Shield	1
18	4820122010	Innensechskant Lochschraube	Screw - M6x12	2
19	0202008000	Sicherungsmutter	Lock Nut - M8	6
20	GM48S000000080/40	AVS Halter rechts	AVS Bracket - R/H	1
21	4510513010/01	Bolzen	Bolt - M8x25	2
22	0102008020	Schraube	Bolt - M8x20	4
23	GM48S000000070/40	AVS Halter links	AVS Bracket - L/H	1

Model:WB486SC AL

Service Code:W486SC100B2011

Blade System

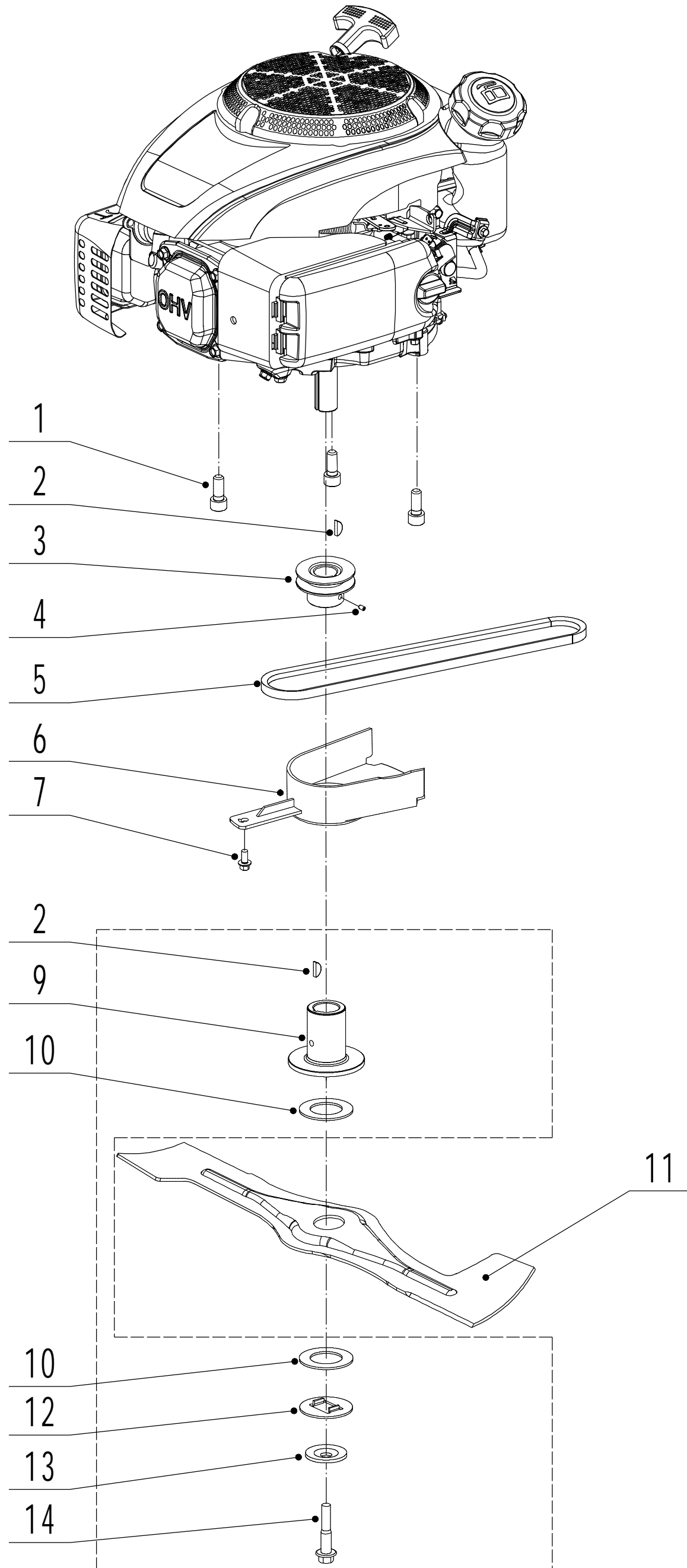

3	Ersatzteilliste		WB 486 SC AL	2025
Nr.	Ersatzteilnummer	Bezeichnung Deutsch	Bezeichnung Englisch	Anzahl
1	4820102010	Schraube	Screw - 3/8x16x28	3
2	5310401010	Keil	Key - B4.7x15.7	2
3	5380402020/02	Riemenscheibe	Engine Pulley	1
4	0105006006	Lochschraube	Screw - M6x6	1
5	4840110011	Keilriemen	Belt - V10x790	1
6	4820402010	Schild	Belt Shield	1
7	4820104010	Schraube	Screw - M6x12	1
9	4510402010	Messerhalter	Blade Boss	1
10	5310402010	Friktionsscheibe	Friction Disc	2
11	4820403010A	Messer	Blade	1
12	5310404010/02	Ring	Locking Disc	1
13	5310406010/04	Scheibe	Dish Washer	1
14	5310415011	Messerbolzen	Blade Bolt - 3/8x24x45	1

Model:WB486SC AL
Service Code:W486SC100B2011
Front Axle

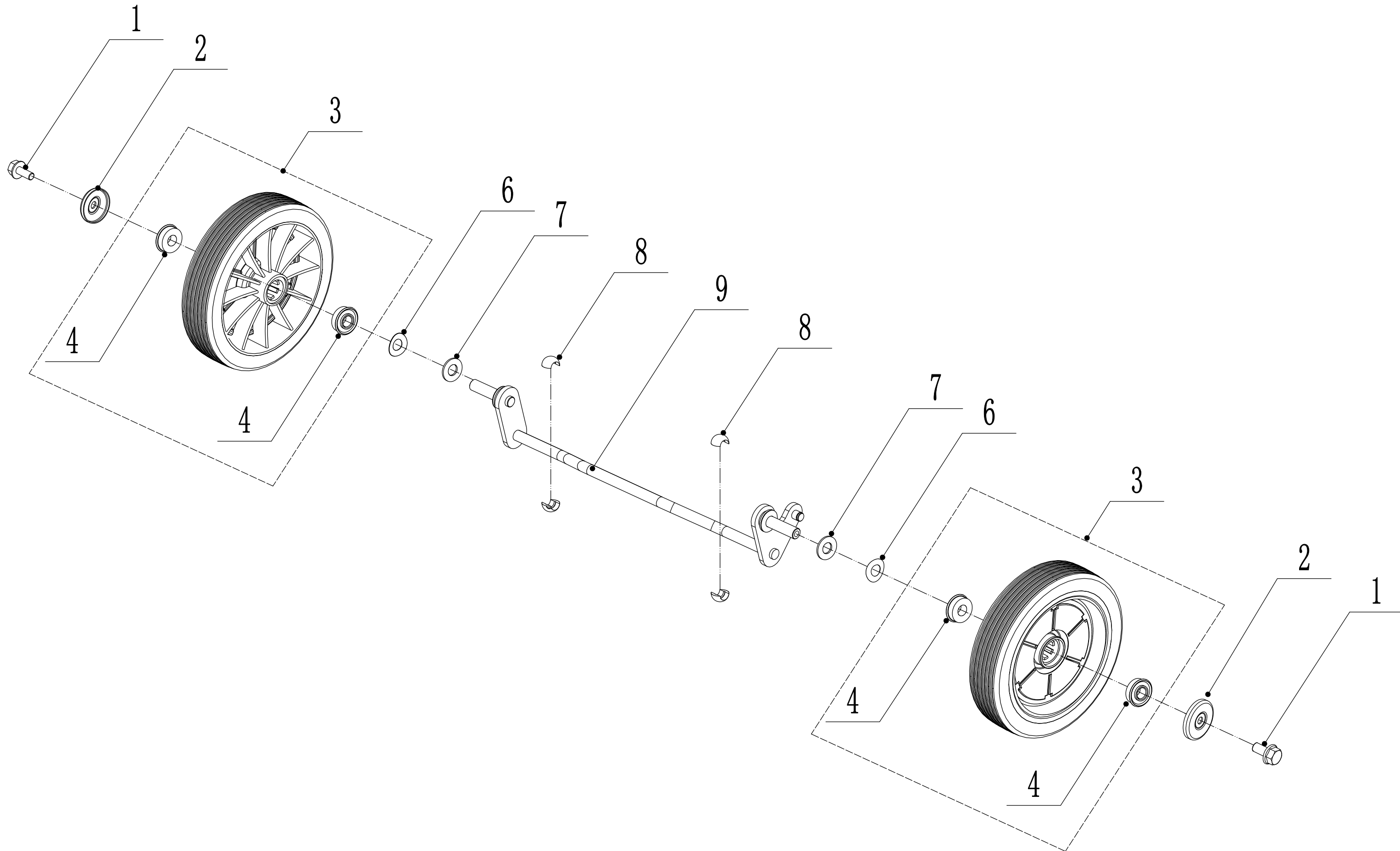

4	Ersatzteilliste WB 486 SC AL 2025			
Nr.	Ersatzteilnummer	Bezeichnung Deutsch	Bezeichnung Englisch	Anzahl
1	0102008016	Bolzen	Bolt - M8x16	2
2	48R0210012/01	Abdeckscheibe	Wheel Cap	2
3	5380205010/40	Rad	Wheel Assembly	2
4	5310213010	Lager	Bearing	4
6	5310211010/02	Federscheibe	Spacer - M12.7	2
7	5310210010/02	Scheibe	Plain Washer - M12.7	2
8	5310209010	Lager	Spherical Bearing	4
9	4820201010/01	Radachse (vorn)	Front Axle	1

Model:WB486SC AL
Service Code:W486SC100B2011
Rear Body

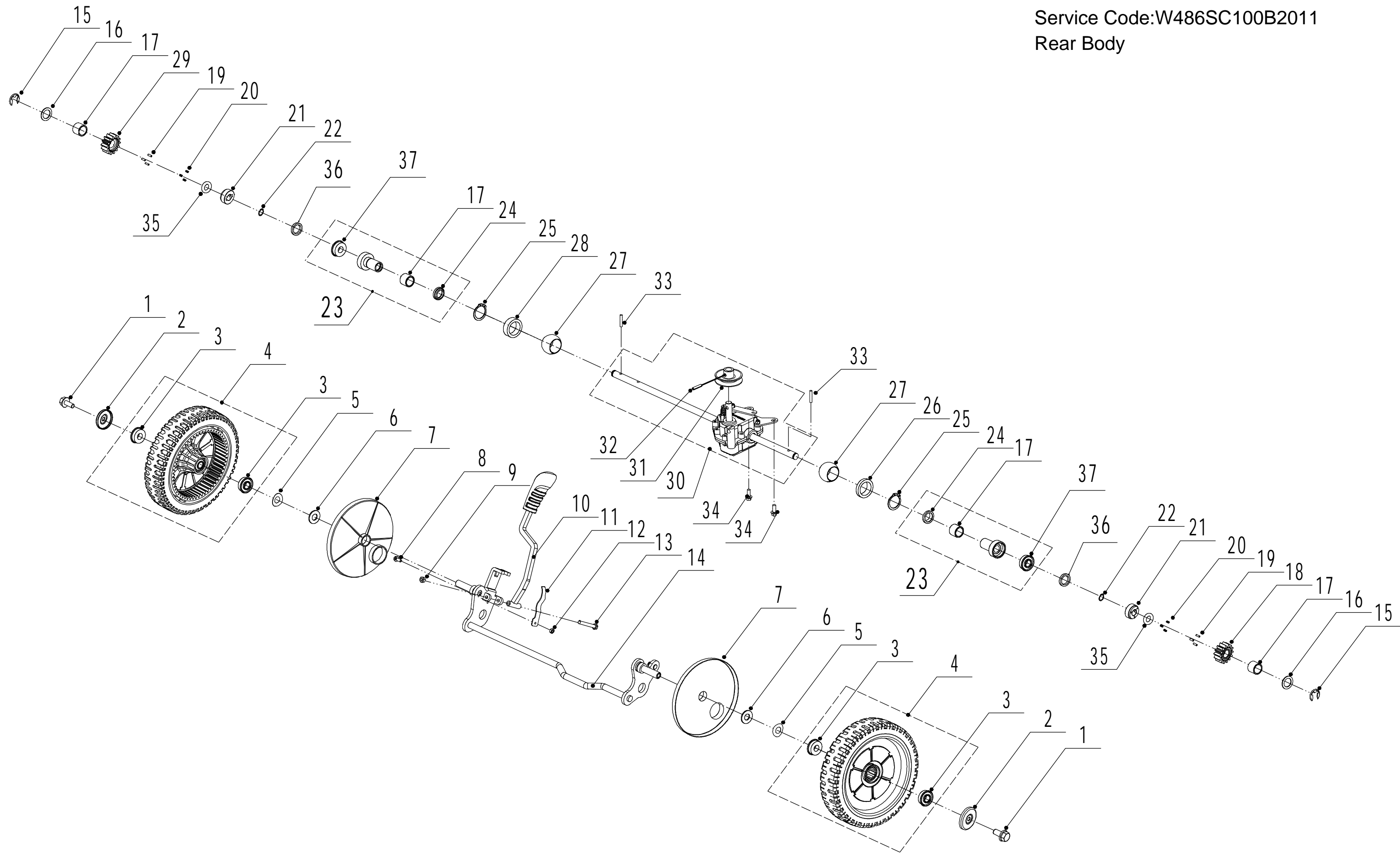

5	Ersatzteilliste WB 486 SC AL 2025			
Nr.	Ersatzteilnummer	Bezeichnung Deutsch	Bezeichnung Englisch	Anzahl
1	0102008016	Bolzen	Bolt - M8x16	2
2	48R0210012/01	Abdeckscheibe	Wheel Cap	2
3	5310213010	Lager	Bearing	4
4	4820305011/40	Rad	Wheel Assembly	2
5	5310211010/02	Federscheibe	Spring Washer - M12.7	2
6	5310210010/02	Scheibe	Plain Washer - M12.7	2
7	4520308010	Rad Abdeckung	Rear Wheel Shield	2
8	0101005016	Bolzen	Bolt - M5x16	1
9	0202006000	Sicherungsmutter	Lock Nut - M6	1
10	5380311010/40	Höheneinstellung	Height Adjustment Lever Component	1
11	5380314010/04	Feder	Armature Spring	1
12	0202005000	Sicherungsmutter	Lock Nut - M5	1
13	0101006055	Bolzen	Bolt - M6x55	1
14	4860301010/01	Hinterachse	Rear Axle Welding	1
15	1301009000	Sicherungsring	E-Clip - M9	2
16	5020311010/04	Scheibe	Washer	2
17	5320326010P	Buchse	Bearing	4
18	HQ000100010	Zahnrad (links)	Drive Pinion - L/H	1
19	HQ000100030	Stift	Pin	6
20	HQ000100040	Feder	Spring	6
21	HQ000100050	Halter	Ratchet	2
22	1001012000	Ring	Circlip - M12	2
23	Y065320	Lager	Bearing Sheath Assembly	2
24	5320327010	Staubabdeckung	Dustproof Ring	2
25	1001020000	Sicherungsring für Welle	Circlip - M20	2
26	4820326010/02	Scheibe	Bearing Bracket Left Washer	1
27	5320328010	Nylon Lager	Nylon Ball Bearing	2
28	5320329010/02	Buchse	Rear Axle Partition	1
29	HQ000100020	Zahnrad (rechts)	Drive Pinion - R/H	1
30	Y204860P	Getriebe	Gearbox	1
31	5020308020	Riemenscheibe Getriebe	Gearbox Pulley	1
32	0701005020	Federstift	Spring Pin - 5x20	1
33	HQ000100060	Stift	Check Holder	2
34	4820104010	Schraube	Screw - M6x12	2
35	1401025015	Ring	O-Ring	2
36	GM48S010000010	Ring	Spacer	2
37	R8-2RS	Kugellager	Deep Groove Ball Bearing	2

Model:WB486SC AL
Service Code:W486SC100B2011
Handle and Controls

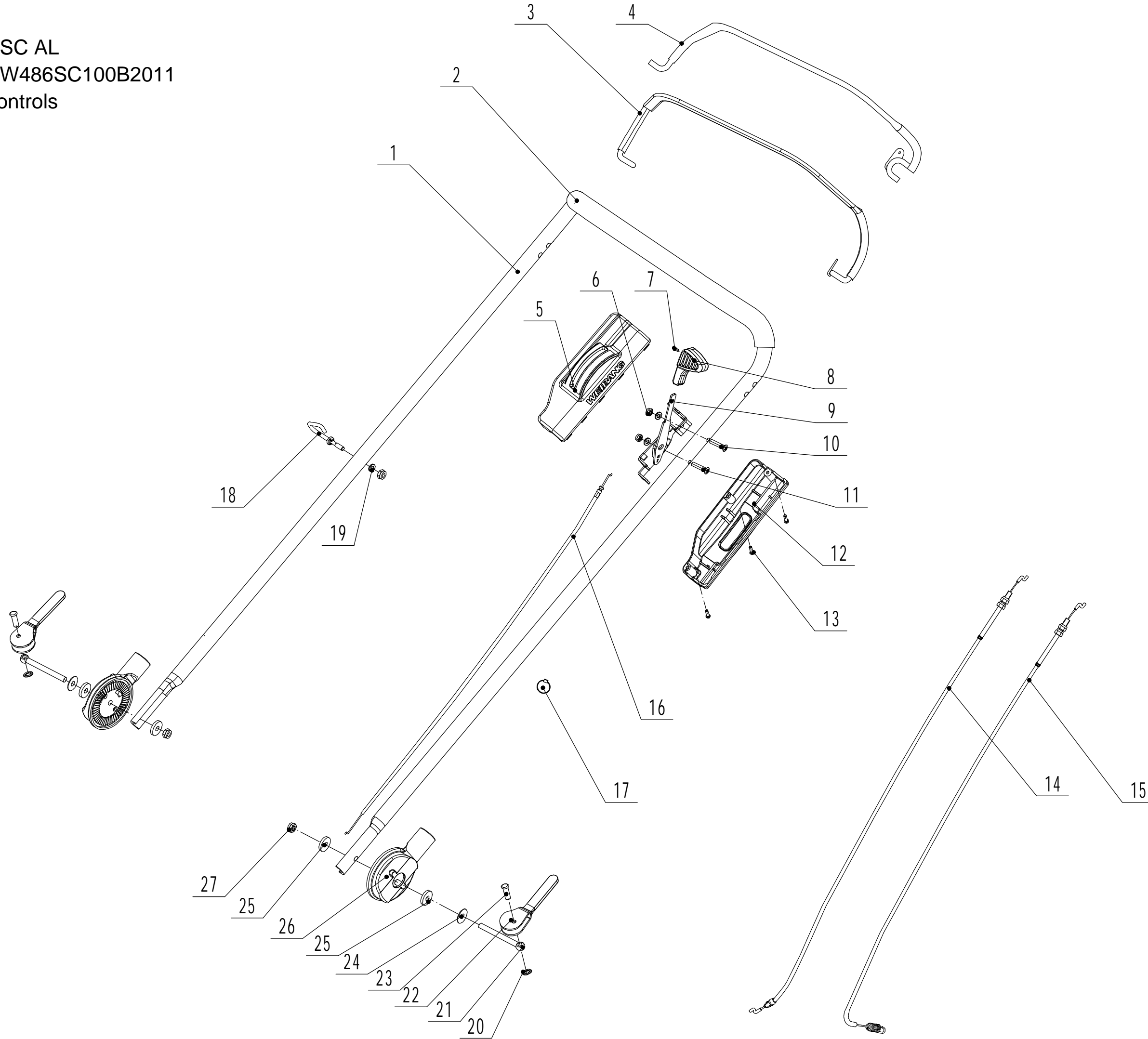

6	Ersatzteilliste WB 486 SC AL 2025			
Nr.	Ersatzteilnummer	Bezeichnung Deutsch	Bezeichnung Englisch	Anzahl
1	5020501020S/49	Holm	Handle	1
2	GM56E010000082	Griffschutz	Handle Sheath	1
3	5320511030S/49	Griff	Clutch Lever	1
4	5320503020S/49	Griff	OPC Lever	1
5	GM46E050000030	Kabelbox obere Hälfte	Throttle Control Box Upper Cover	1
6	0202006000	Sicherungsmutter	Lock Nut - M6	3
7	0106003013	Schraube	Screw - ST2.9x13	1
8	5380510010	Kappe für Gasgriff	Throttle Control Grip	1
9	GM46B050100000	Gashebel	Frame - Throttle Control	1
10	0108006040	Schraube	Screw - M6x40	1
11	0108006050	Schraube	Screw - M6x50	1
12	GM46E050000040	Kabelbox untere Hälfte	Throttle Control Box Lower Cover	1
13	0113040018	Schraube	Screw - ST4x18	3
14	BS120-1140	Motorbremszug	OPC Cable	1
15	LH194-1195	Kupplungskabel	Clutch Cable	1
16	YM72-970-A	Gaszug	Throttle Cable	1
17	ZD8/200	Kabelbinder	Cable Tie - 8x200mm	1
18	4510511010/01	Kabelhalter	Hook - Starter Rope	1
19	0301006000	Scheibe	Washer - M6	3
20	4510114030	Buchse	Fix Cap	2
21	GM48S000000100	Bolzen	Connecting Bolt	2
22	GM56A100400000	Hebel	Lock Lever	2
23	0801008025	Stift	Axis Pin - 8x25	2
24	GM56A100000040/04	Scheibe	Spacer	2
25	GM56A100000050/01	Scheibe	Spacer	3
26	GM48S030200000	Verstellsegment	Tooth Disc Kit	2
27	0203008000	Mutter	Lock Nut - M8	2

Model:WB486SC AL
Service Code:W486SC100B2011
Grass Catcher

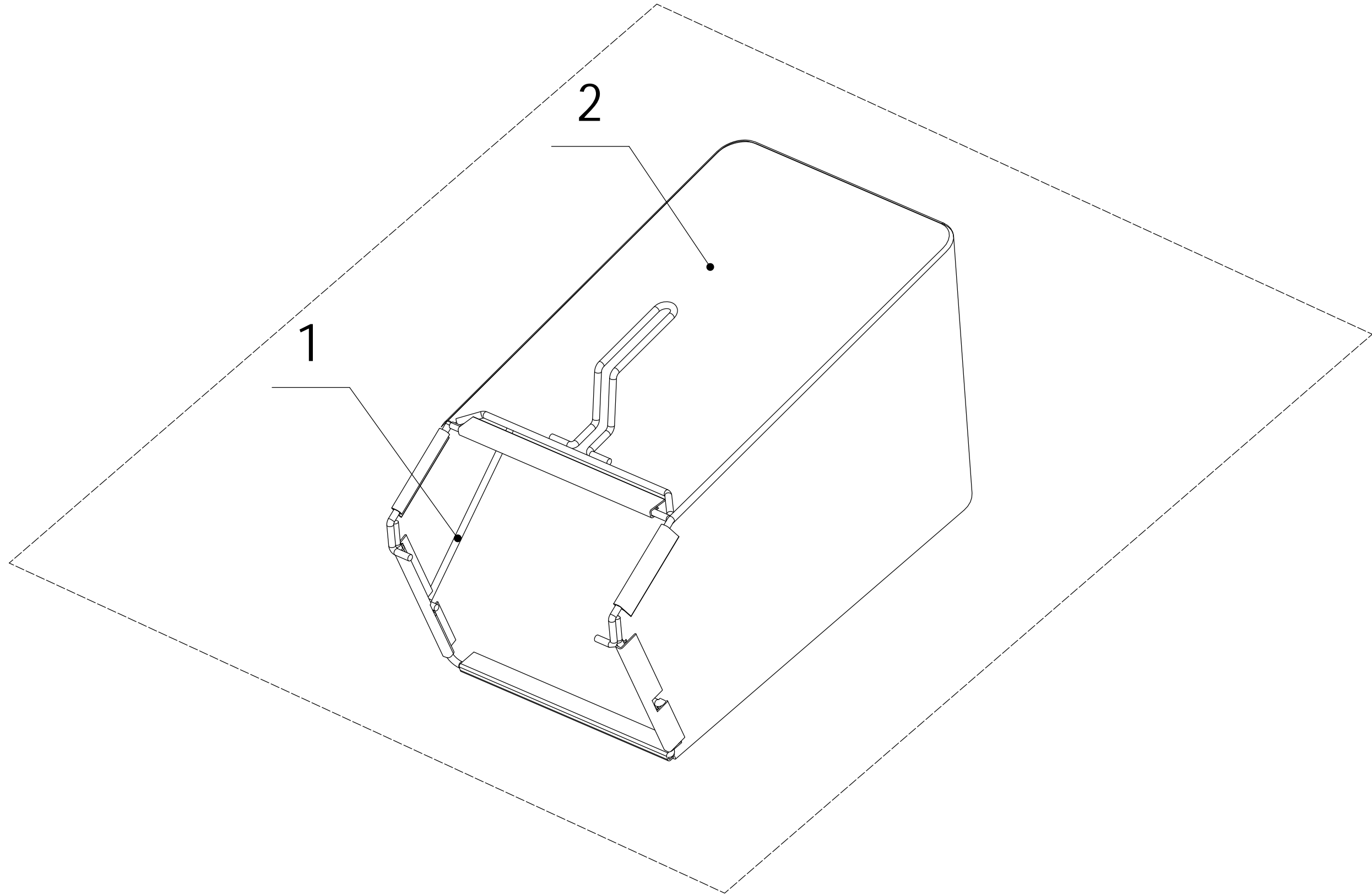

7	Ersatzteilliste			WB 486 SC AL	2025
Nr.	Ersatzteilnummer	Bezeichnung Deutsch	Bezeichnung Englisch	Anzahl	
1	4860602010S/22	Gestell	Grass Bag Frame	1	
2	4820611010S/84	Fangsack	Grass Bag	1	

Model:WB486SC AL
Service Code:W486SC100B2011
Belt Tensioner

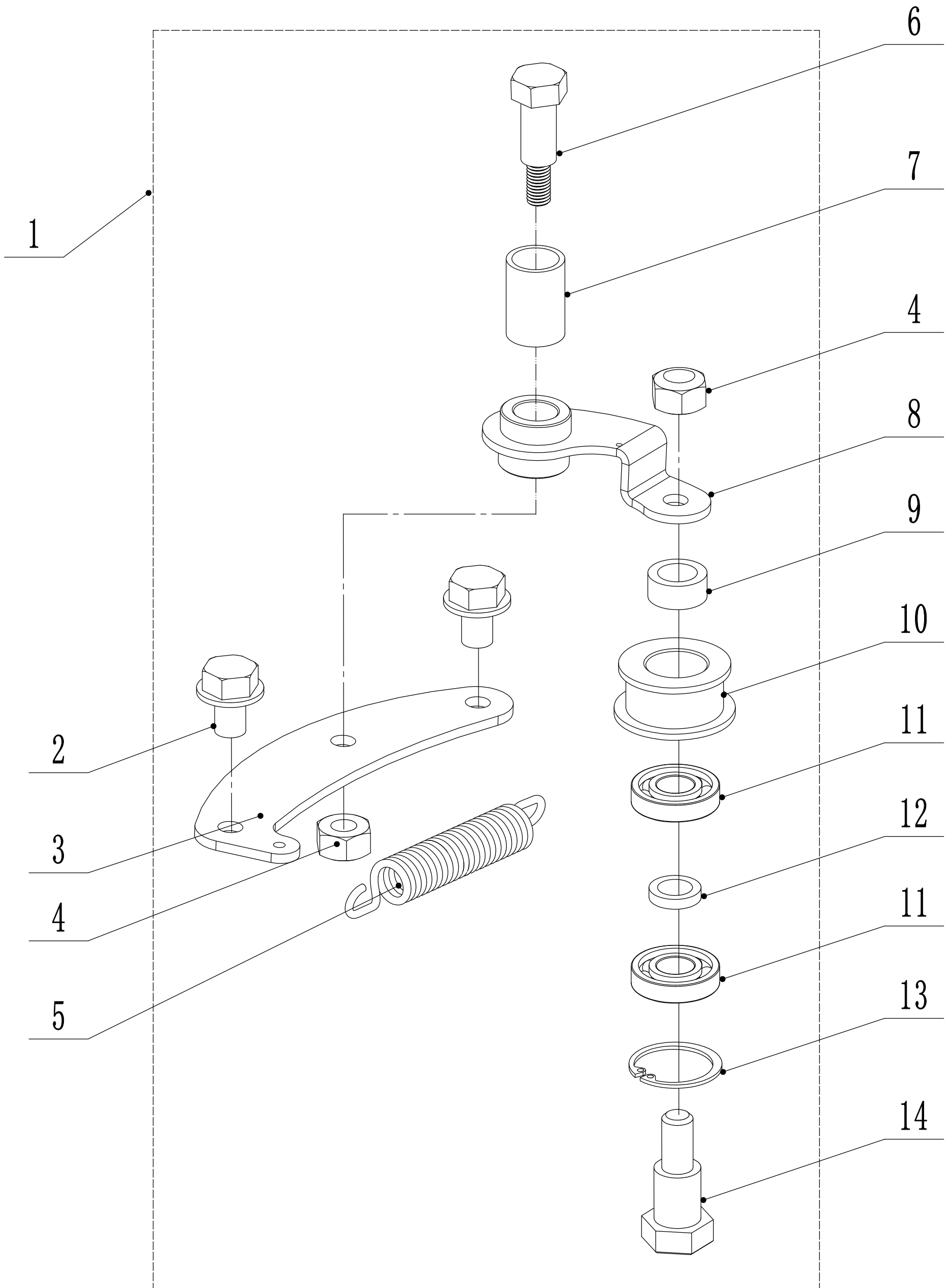

8	Ersatzteilliste WB 486 SC AL 2025			
Nr.	Ersatzteilnummer	Bezeichnung Deutsch	Bezeichnung Englisch	Anzahl
1	Y095341	Keilriemenspannung komplett	Belt Tensioner Assembly	1
2	4820113010	Bolzen	Screw - 5/16x18x16	2
3	5340124010/02	Platte	Tensional Arm Bracket	1
4	0202008000	Sicherungsmutter	Lock Nut - M8	2
5	5340127010	Feder	Spring	1
6	5340126010/02	Zentralbolzen	Central Bolt	1
7	4820112010	Kunststoffbuchse	Nylon Bush	1
8	5340125010/02	Halter	Swinging Arm Welding	1
9	5340129010/02	Buchse	Spacer1	1
10	5340128010	Riemenscheibe	Tensional Pulley	1
11	609-2RS	Kugellager	Bearing	2
12	5340130010/02	Buchse	Spacer2	1
13	0901024000	Sicherungsring	Circlip - 24mm	1
14	5340131010/02	Bolzen	Tensional Pulley Bolt	1