

2 Main Body

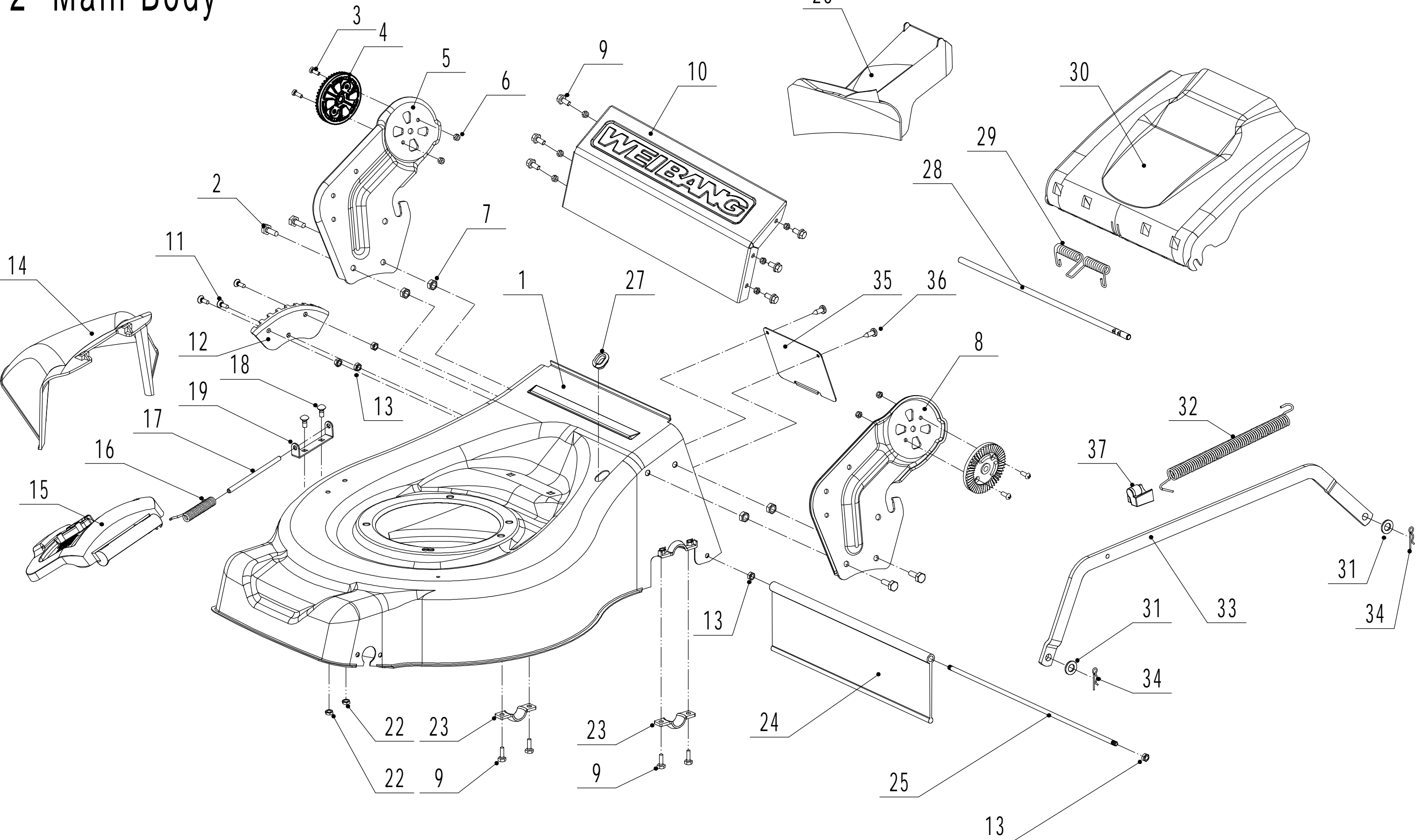

2	Ersatzteilliste WB 456 SC V 3-1			2025
Nr.	Ersatzteilnummer	Bezeichnung Deutsch	Bezeichnung Englisch	Anzahl
1	4560101004/49	Gehäuse	Chassis	1
2	0102008016	Bolzen	Bolt - M8x16	4
3	0104005012	Schraube	Screw - M5x12	4
4	AVSA000000040/22	Schnellverschluß	Tooth Disc	2
5	4560112010K/40	Halter (rechts)	Right Bracket	1
6	0202005000	Sicherungsmutter	Lock Nut - M5	4
7	0202008000	Sicherungsmutter	Lock Nut - M8	4
8	4560111010K/40	Halter (links)	Left Bracket	1
9	0102006012	Bolzen	Bolt - M6x12	10
10	4560111030K/49	Verbindungsstück	Connector	1
11	0104006016	Schraube	Screw - M6x16	3
12	4560110010/01	Höheneinstellung	Graduator	1
13	0202006000	Sicherungsmutter	Lock Nut - M6	9
14	4560108010	Auswurfklappe	Side Discharge Deflector	1
15	4560107012	Seitenauswurfklappe	Side Discharge Cover Kit	1
16	5020119010	Feder	Spring - Side Discharge Cover	1
17	5020120010/02	Stange	Pivot - Side Discharge Cover	1
18	0107006014	Bolzen	Bolt - M6x14	2
19	5020118010/02	Federhalter	Side Discharge Cover Bracket	1
22	0204006000	Mutter	Lock Nut - M6	2
23	5320114020/01	Halter	Upper Bearing Bracket	2
24	4320119010	Hinterer Ablenker	Trailing Flap	1
25	4320118010/02	Stange	Pivot - Trailing Flap	1
26	4560104010	Mulchstopfen	Mulching Plug	1
27	5360122010	Gummiring	Rubber Ring	1
28	4560106010/02	Stange	Rear Cover Pivot	1
29	5360118010	Feder	Rear Cover Spring	1
30	4560105010	Abdeckung (Fangsack)	Rear Cover	1
31	0301010000	Scheibe	Flat Washer - M10	2
32	WB2100020102/01	Feder	Spring - Connecting Rod	1
33	4560109011/40	Verbindungsstange	Connecting Rod	1
34	5320333010	Federsplint	Check Ring	2
35	5360105010D/49	Umlenklech	Baffle	1
36	0106004009	Bolzen	Screw - 4.2x9.5	2
37	4560109012	Halterung	Spring Bracket	1

3 Blade system

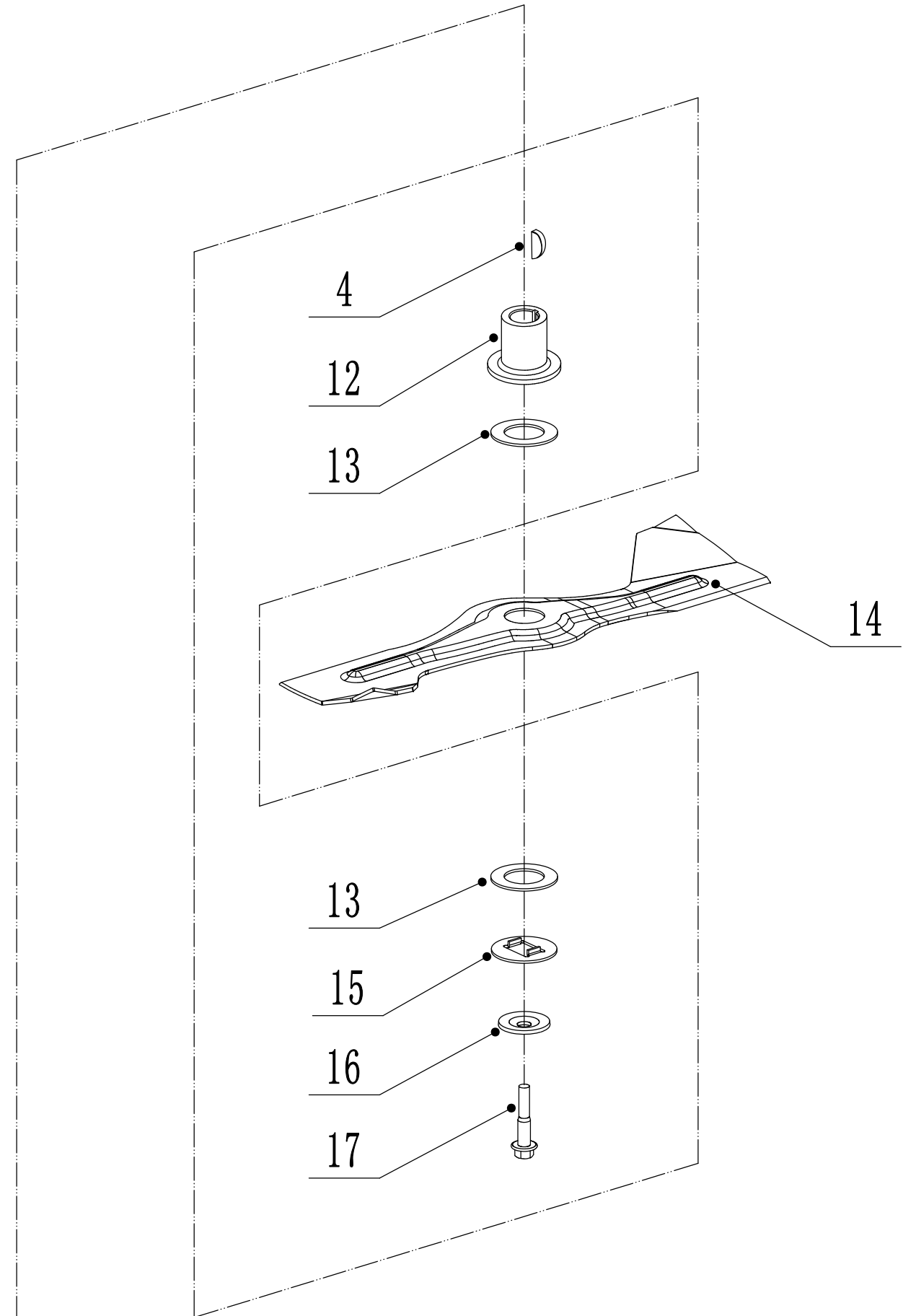
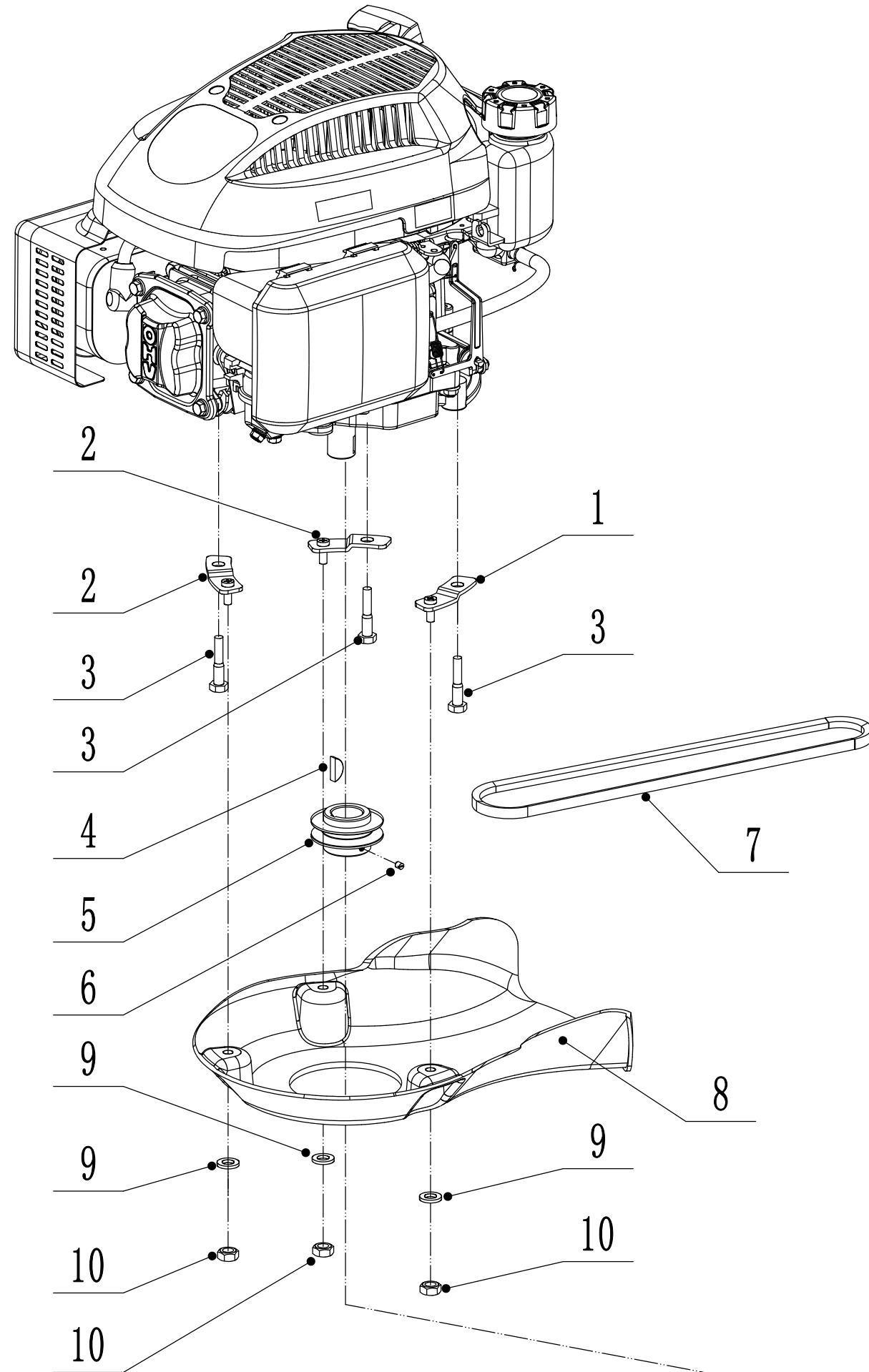

3	Ersatzteilliste WB 456 SC V 3-1			2025
Nr.	Ersatzteilnummer	Bezeichnung Deutsch	Bezeichnung Englisch	Anzahl
1	5360111010/02	Unterlegscheibe	Engine Washer 1	1
2	5360112010/02	Unterlegscheibe	Engine Washer 2	2
3	5320115010	Schraube	ST screw - 3/8x16x25	3
4	4510401010	Keil	Key	2
5	4560402040/02	Riemenscheibe	Engine Pulley	1
6	0105006006	Lochschraube	Locking Screw	1
7	4560114010	Keilriemen	V Belt - V10x815 (30°)	1
8	4560102010	Riemenschutz	Belt Shield	1
9	0302006000	Scheibe	Big Flat Washer	3
10	0202006000	Sicherungsmutter	Lock Nut - M6	3
12	5320404020/02	Messerhalter	Adaptor	1
13	5310402010	Friktionsscheibe	Friction Washer	2
14	4510403010A	Messer	Blade	1
15	5310404010/02	Ring	Lock Disc	1
16	5310406010/04	Scheibe	Dish Washer	1
17	5320405011	Messerbolzen	Central Bolt - 3/8x24x55	1

4 Front Axle

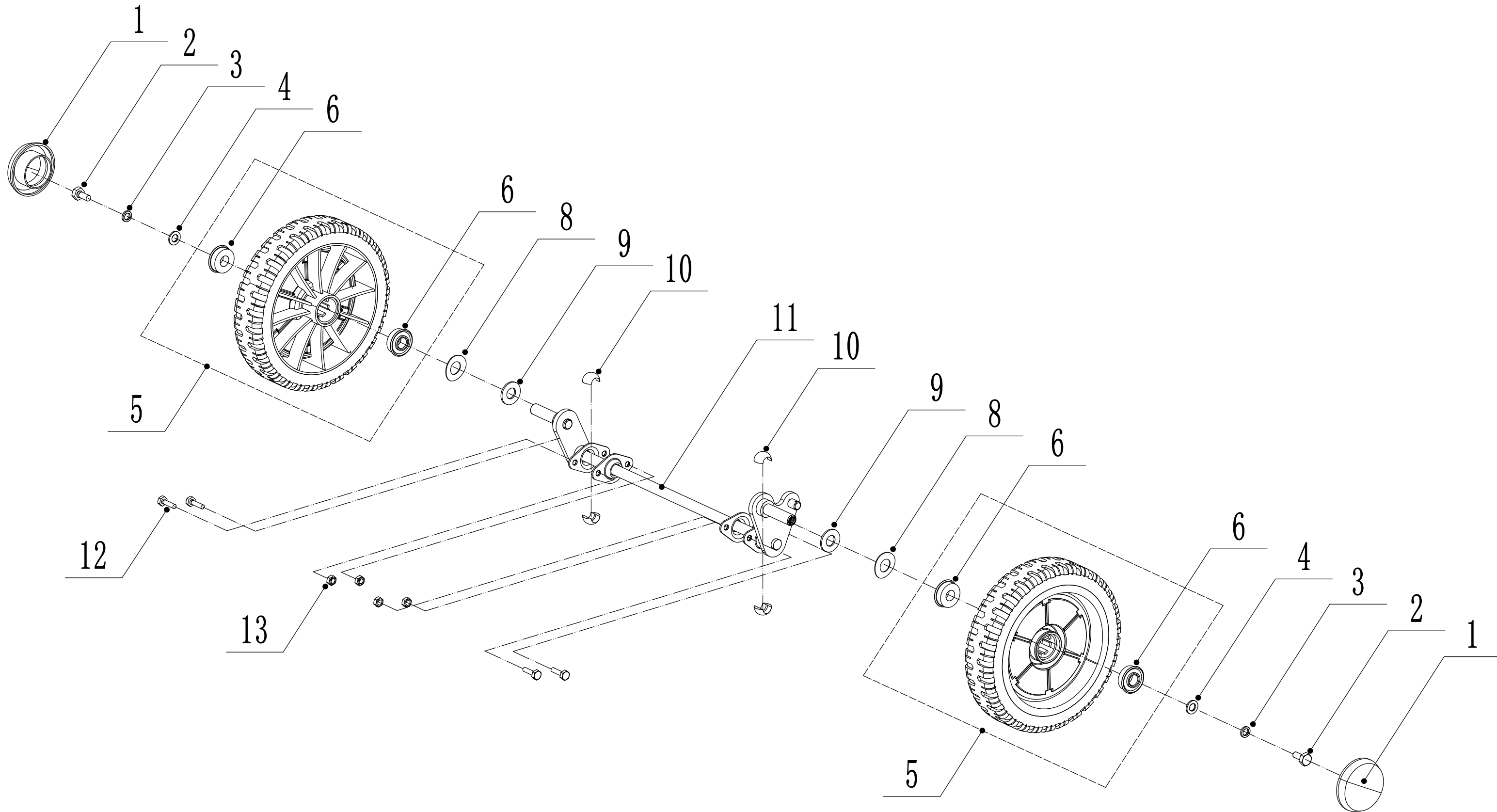

4	Ersatzteilliste WB 456 SC V 3-1			2025
Nr.	Ersatzteilnummer	Bezeichnung Deutsch	Bezeichnung Englisch	Anzahl
1	5310214010	Radkappe	Wheel Cap	2
2	0101008015	Bolzen	Bolt - M8x15	2
3	0401008000	Federscheibe	Spring Washer	2
4	0301006000	Scheibe	Flat Washer	2
5	4510210010/40	Rad (grau)	Wheel	2
6	5310213010	Lager	Bearing	4
8	5310211010/02	Federscheibe	Spacer	2
9	5310210010/02	Scheibe	Axis Washer	2
10	5310209010	Lager	Ball Bearing	4
11	4560201010/01	Frontachse	Front Axle	1
12	0102006012	Bolzen	Bolt - M6x12	4
13	0202006000	Sicherungsmutter	Lock Nut - M6	4

5 Rear axle

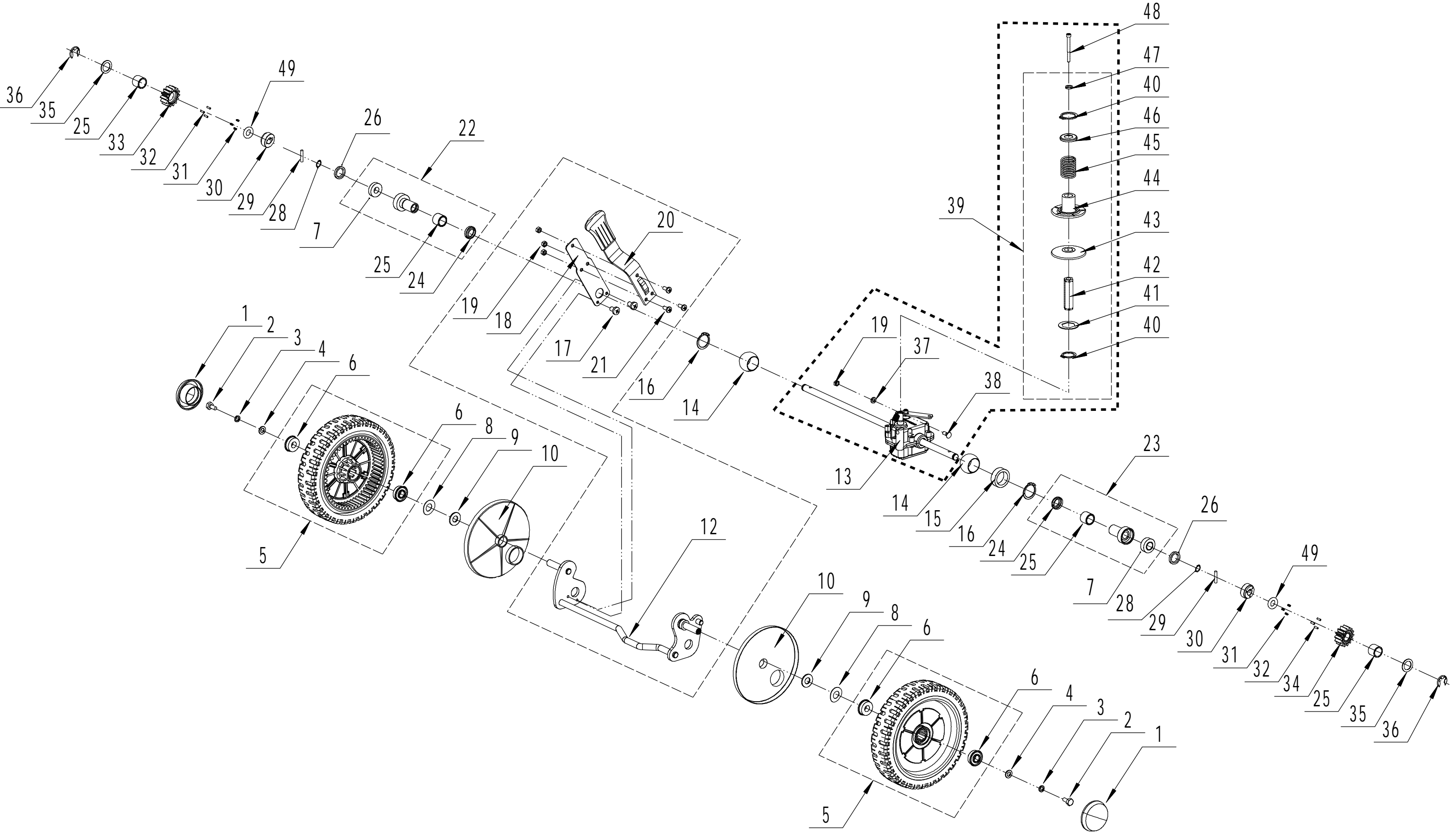

5	Ersatzteilliste WB 456 SC V 3-1			2025
Nr.	Ersatzteilnummer	Bezeichnung Deutsch	Bezeichnung Englisch	Anzahl
1	5310214010	Radkappe	Wheel Cap	2
2	0101008015	Bolzen	Bolt - M8x15	2
3	0401008000	Federscheibe	Spring Washer - M8	2
4	0301008000	Unterlegscheibe	Flat Washer - M8	2
5	5340309010/40	Hinterrad (grau)	Wheel	2
6	5310213010	Lager	Bearing	6
7	R8-2RS	Kugellager	Bearing	2
8	5310211010/02	Federscheibe	Spacer	2
9	5310210010/02	Scheibe	Axis Washer	2
10	5340312010	Schutz	Anti-Dust Shield	2
12	4560301010/01	Hintere Welle	Rear Axle	1
13	Y20456V0P	Getriebe	Gearbox Assembly	1
14	5320328010	Nylon Lager	Nylon Spherical Bearing	2
15	5320329010/02	Buchse	Rear Axle Partition	1
16	1001020000	Sicherungsring	Check Ring For Shaft	2
17	0113005008	Schraube	Screw - M5x8	2
18	5360311010/22	Halter	Spring Of Adjustment Lever	1
19	0202006000	Sicherungsmutter	Lock Nut - M6	3
20	5360310010/40	Höhenverstellhebel	Adjustment Lever	1
21	0101006014	Bolzen	Bolt - M6x14	3
22	Y065321	Lager	Left Bearing Sheath Assembly	1
23	Y065320	Lager	Right Bearing Sheath Assembly	1
24	5320327010	Staubabdeckung	Dustproof Ring	2
25	5320326010P	Buchse	Bearing	4
26	GM48S010000010	Ring	Spacer	2
28	1001012000	Ring	Check Ring For Shaft	2
29	HQ000100060	Stift	Pin For Ratchet	2
30	HQ000100050	Halter	Ratchet	2
31	HQ000100040	Feder	Spring	6
32	HQ000100030	Stift	Pin	6
33	HQ000100020	Zahnrad (rechts)	Right Drive Pinion	1
34	HQ000100010	Zahnrad (links)	Left Drive Pinion	1
35	5020311010/04	Scheibe	Anti-friction Mat	2
36	1301009000	Sicherungsring	Check Ring - M9	2
37	0301006000	Scheibe	Flat Washer - M6	1
38	0107006014	Bolzen	Square Neck Bolt - M6x14	1
39	Y115380	Ring	Transmission Assembly	1
40	1001017000	Sicherungsring	Check Ring For Shaft	2
41	4820320010/02	Scheibe	Inner Hex Washer	1
42	4820321010/02	Schutz	Hex Adaptor	1
43	5380309010	Variatorhälfte	Lower Pulley Disc	1
44	5380308010	Variatorhälfte	Active Pulley Disc	1

45	4820324010	Feder	Pressing Spring	1
46	4820325010/02	Federschutz	Spring Cap	1
47	0401005000	Scheibe	Spring Washer - M5	1
48	0103005055	Innensechskantschraube	Inner Hex Bolt - M5x55	1
49	1401025015	Ring	O-Sealing Ring	2

6 Handle And Controls

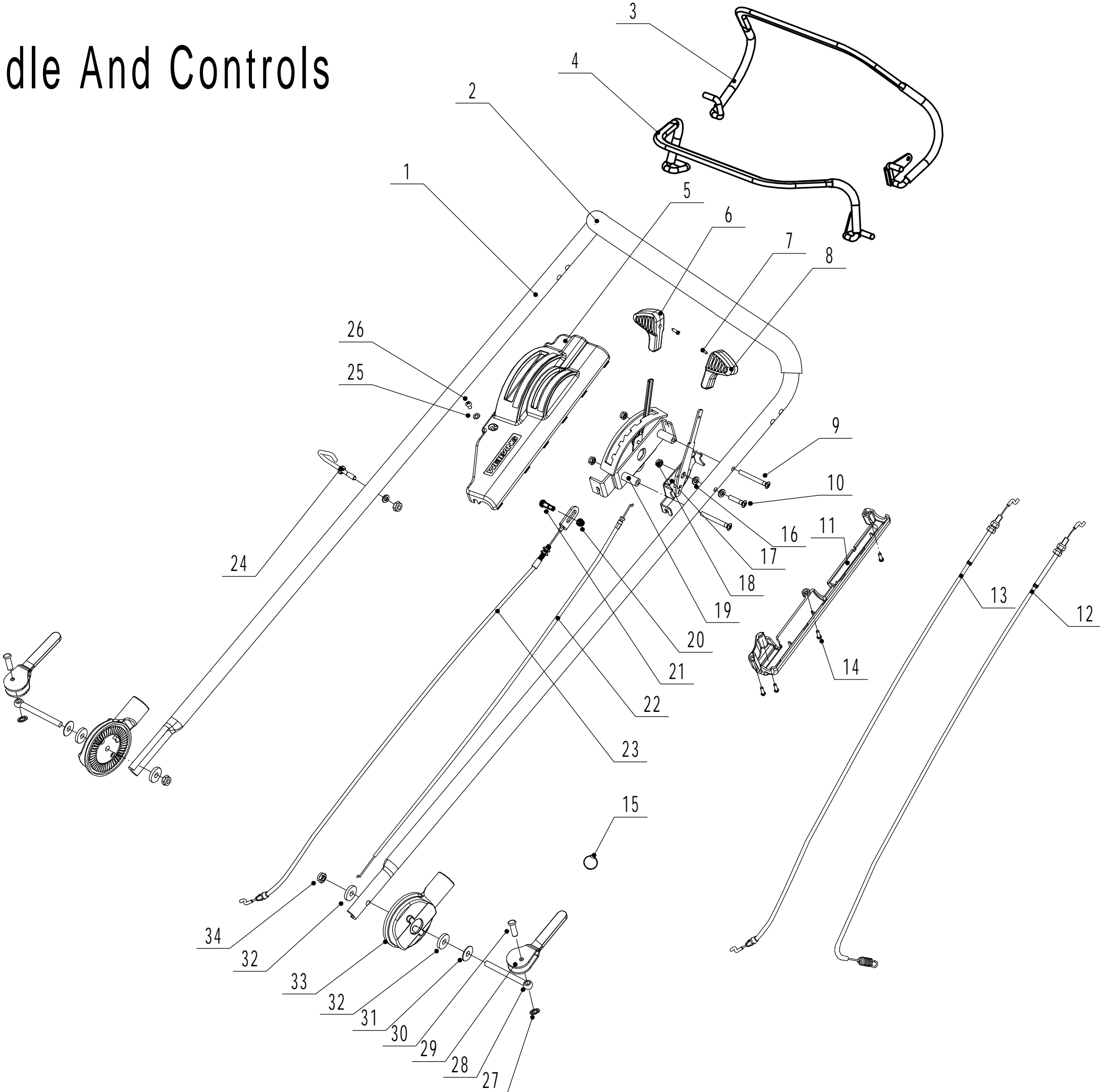

6	Ersatzteilliste		WB 456 SC V 3-1	2025
Nr.	Ersatzteilnummer	Bezeichnung Deutsch	Bezeichnung Englisch	Anzahl
1	4560115010/49	Griff	Handle	1
2	GM56E010000082	Griffschutz	Handle Sheath	1
3	5020506030S/40	Kupplungsgriff	Clutch Lever Weldment	1
4	5020503020S/40	Bremsgriff	Brake Lever Weldment	1
5	5020501030S	Schutz	Control Box Upper Cover	1
6	5380508010	Knopf	Speed Control Grip	1
7	0106003013	Schraube	Screw - ST2.9x13	2
8	5380510010	Kappe für Gasgriff	Throttle Grip	1
9	0108006060	Schraube	Screw - M6x60	2
10	0108006050	Schraube	Screw - M6x50	1
11	5020501040S	Schutz	lower cover	1
12	LH194-1195	Kupplungskabel	Clutch Cable	1
13	BS120-1140	Motorbremszug	Brake Cable	1
14	0113040018	Schraube	Screw	4
15	ZD8/200	Kabelbinder	Cable tie	1
16	0301006000	Scheibe	Spacer - M6	3
17	5380512010	Hebel	Throttle Bracket	1
18	0202006000	Sicherungsmutter	Lock Nut - M6	4
19	5360505010K	Geschwindigkeitsregulierung	Speed Control Bracket	1
20	0202005000	Sicherungsmutter	Lock Nut - M5	1
21	5360506011	Schraube	Speed Control Cable Bolt	1
22	YM72-1010-A	Gaszug	Throttle Cable	1
23	TX123-1035-A	Variobowdenzug	Speed Control Cable	1
24	4510511010/01	Kabelhalter	Cable Hook	1
25	0301005000	Unterlegscheibe	Washer	1
26	0104005008	Bolzen	Screw - M5x8	1
27	4510114030	Buchse	Fix Cap	2
28	GM48S000000100	Bolzen	Connecting Bolt	2
29	GM56A100400000	Hebel	Lock Lever	2
30	0801008025	Stift	Axis Pin	2
31	GM56A100000040/04	Scheibe	Spacer	2
32	GM56A100000050/01	Scheibe	Spacer	4
33	GM48S030200000	Verstellsegment	Tooth Disc Kit	2
34	0203008000	Mutter	Lock Nut - M8	2

7 Grass Catcher

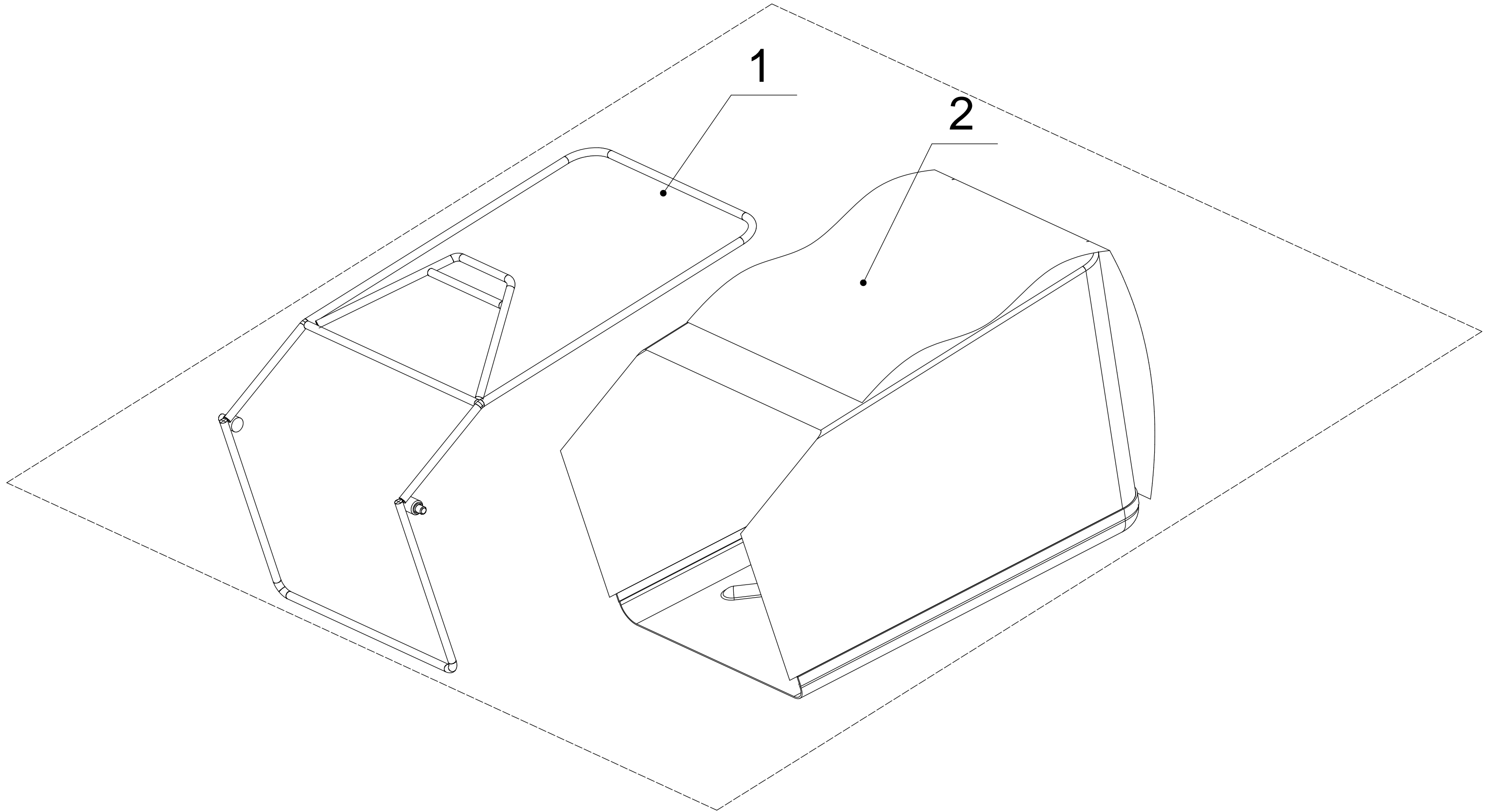

7	Ersatzteilliste			WB 456 SC V 3-1	2025
Nr.	Ersatzteilnummer	Bezeichnung Deutsch	Bezeichnung Englisch	Anzahl	
1	4560602010/22	Gestell	Grass Catcher Frame	1	
2	4560603010/84	Fangsack	Grass Bag	1	

8 Tensional part

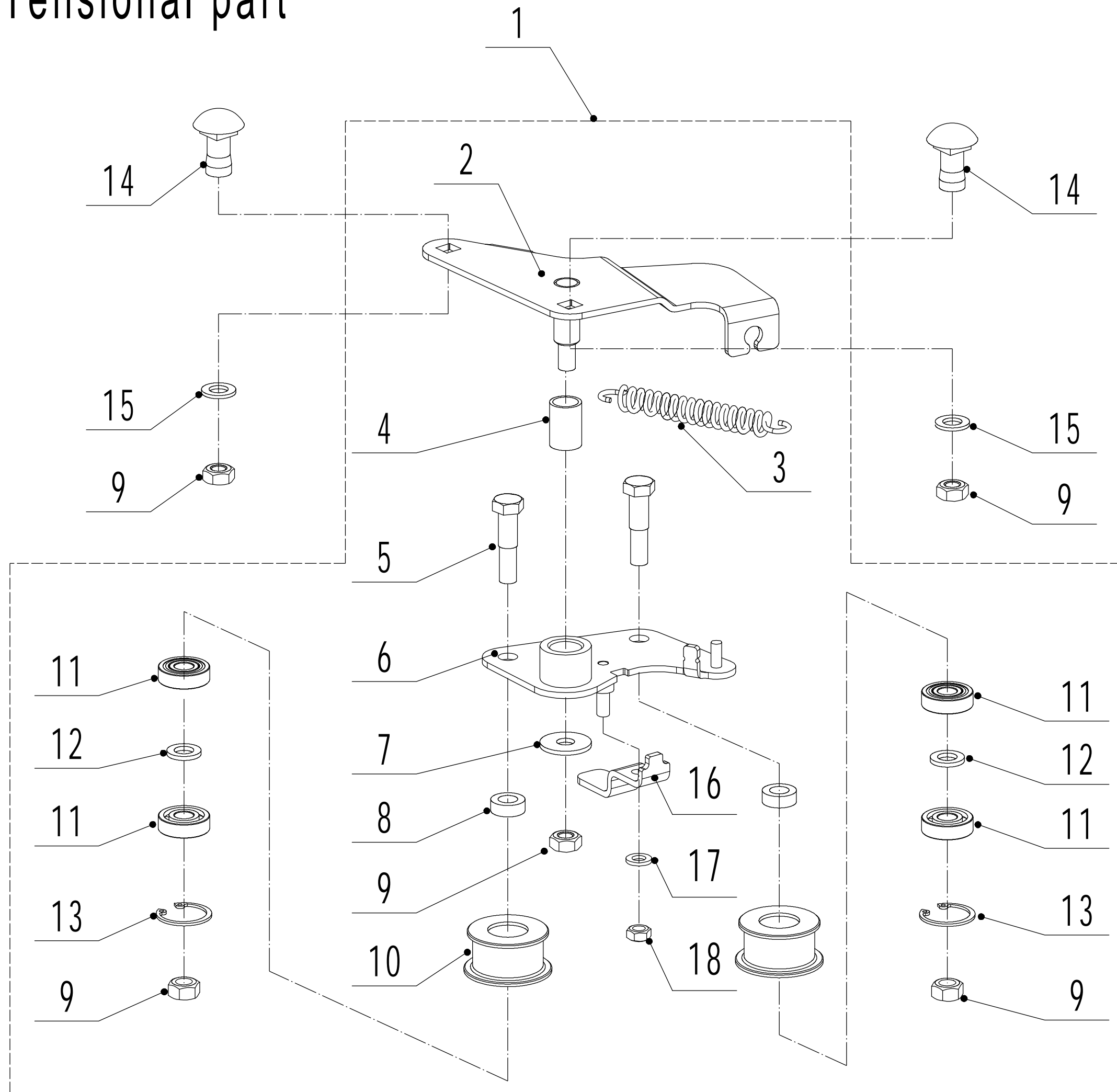

8	Ersatzteilliste WB 456 SC V 3-1			2025
Nr.	Ersatzteilnummer	Bezeichnung Deutsch	Bezeichnung Englisch	Anzahl
1	Y094560A1	Spannvorrichtung Vario	Tensional Pully Assembly	1
2	5040114010A1/02	Halter	Tensional Arm Bracket	1
3	4820114010	Feder	Tensional Spring	1
4	4820112010	Kunststoffbuchse	Nylon Bush	1
5	5340131010/02	Bolzen	Tensional Pulley Bolt	2
6	5040115010A1/02	Halterung	Tensional Arm Weldment	1
7	0302008000	Unterlegscheibe	Big Flat Washer - M8	1
8	5340129010/02	Buchse	Spacer1	2
9	0202008000	Sicherungsmutter	Lock Nut - M8	5
10	5340128010	Riemenscheibe	Tensional Pulley	2
11	609/2RS	Kugellager	Bearing	4
12	5340130010/02	Buchse	Spacer2	2
13	1001024000	Ring	Check Ring For Shaft	2
14	0107008016	Bolzen	Square Neck Bolt - M8x16	2
15	0301008000	Unterlegscheibe	Flat Washer - 8	2
16	5040122010/02	Platte	Belt limit plate	1
17	0301006000	Scheibe	Flat Washer - 6	1
18	0202006000	Sicherungsmutter	Nut - M6	1