

Model:WB455SC-OP
Service code:W455SC-OP2000
Main body and Blade system

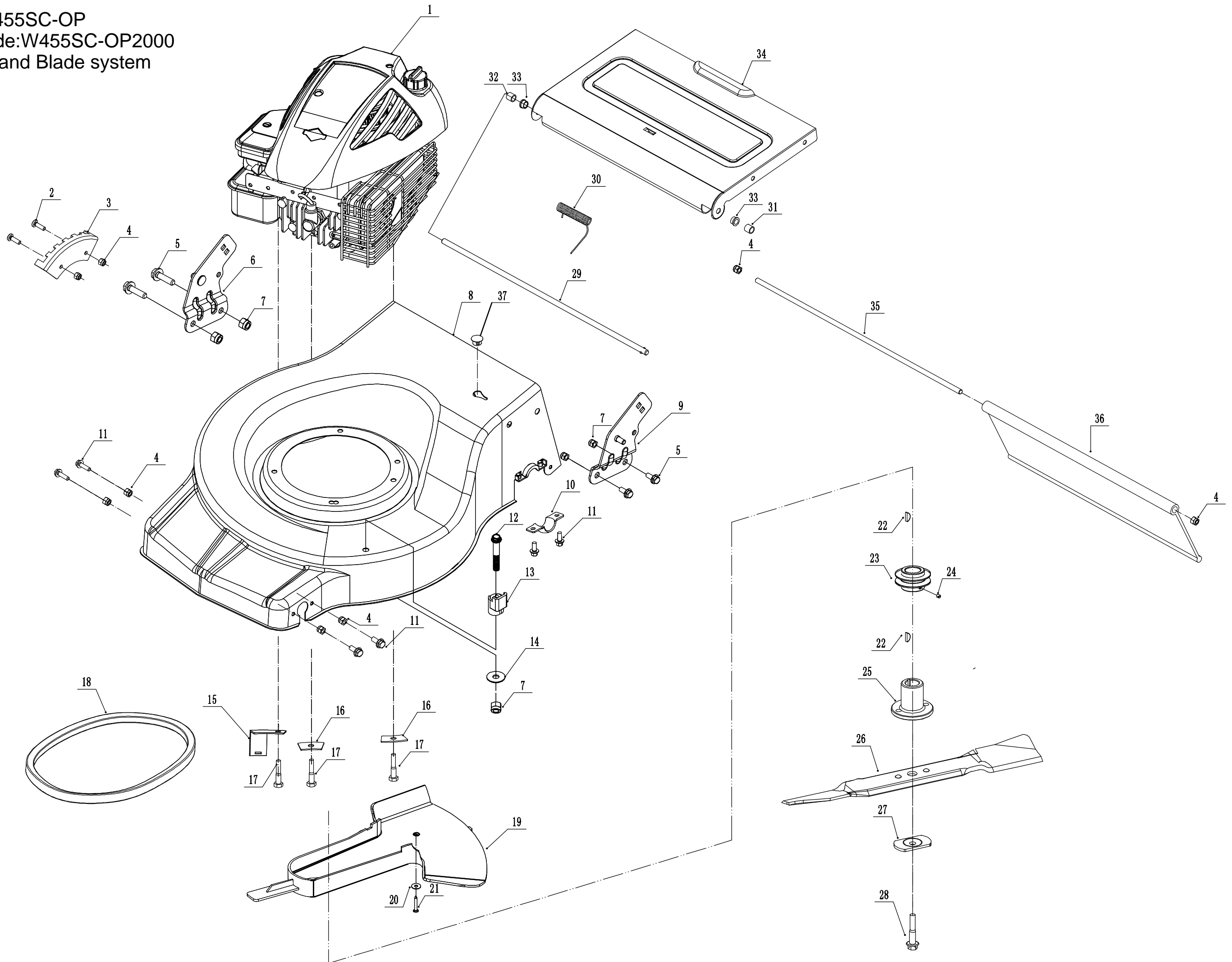

1	2025	WB 455 SC-OP	Ersatzteilliste	
Nr.	Ersatzteilnummer	Bezeichnung Deutsch	Bezeichnung Englisch	Anzahl
1	LC1P65FEK8612	Motor	Engine	1
2	0101006014	Bolzen M6x14	Bolt - M6x14	2
3	4510107010/01	Höheneinstellung	Graduator	1
4	0202006000	Sechskant Sicherungsmutter	Lock Nut - M6	8
5	0102010016	Bolzen	Bolt - M10x16	4
6	4510109020	Holmhalter Rechts	Bracket - R/H	1
7	0202010000	Sicherungsmutter	Lock Nut -M10	5
8	4520101010/49	Gehäuse	Chassis	1
9	4510108020	Holmhalter Links	Bracket - L/H	1
10	5320114020/01	Halter	Upper Bearing Bracket	2
11	0102006012	Bolzen	Bolt - M6x12	4
12	0102010045	Bolzen	Bolt - M10x45	1
13	5310317010	Schraubenhalterung	Tension spring base	1
14	0302010000	Scheibe	Flat washer - ϕ 10	1
15	5020112010/01	Halter	Guard bracket	1
16	5310112020/02	Scheibe	Spacer	3
17	5320115010	Schraube	Lock Screw	3
18	4320104012	Keilriemen	Belt - V10x735mm	1
19	4520109010	Schutz	Belt guard	1
20	0302005000	Scheibe	Flat washer - ϕ 5	1
21	0106004025	Schraube	Screw - 4.2x25	1
22	4510401020	Keil	Key	2
23	4520403016/01	Motorriemenscheibe	Engine pulley	1
24	0105006006	Lochschraube	Lock Screw - M6x6	1
25	4510402030	Messerhalter	Adapter	1
26	4510404010/32	Messer	Blade	1
27	4510407010/04	Unterlegscheibe	Spring Washer	1
28	5310415010	Messerbolzen	Central Bolt	1
29	4510114020/02	Stange	Shaft	1
30	4510115010	Feder	Spring	1
31	5320136010/02	Buchse	Spacer	1
32	5320137010/02	Scheibe	Spacer	1
33	5320127021	Nylon Buchse	Nylon Spacer	2
34	4510113020/22	Klappe (Auswurfkanal)	Grass Bag Flap	1
35	4510112010/02	Stange	Shaft	1
36	4510111010	Schutz (hinten)	Trailing Flap	1
37	4520514010	Buchse	Spacer	1

Model:WB455SC-OP
Service code:W455SC-OP2000
Axle

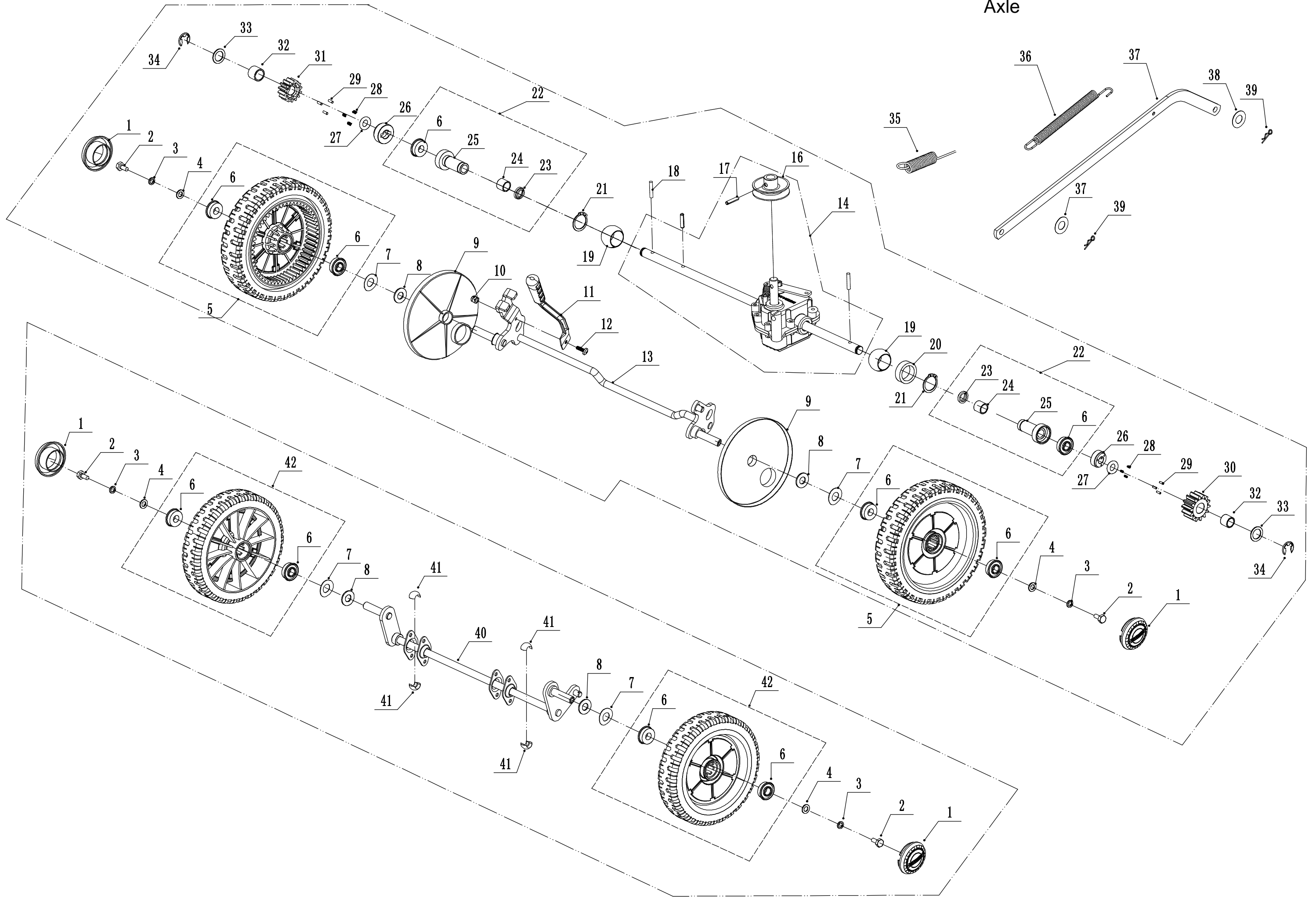

2	2025	WB 455 SC-OP		Ersatzteilliste
Nr.	Ersatzteilnummer	Bezeichnung Deutsch	Bezeichnung Englisch	Anzahl
1	5310214010	Radkappe	Wheel Cap	4
2	0101008015	Bolzen	Bolt - M8x15	4
3	0401008000	Federscheibe	Spring Washer - M8	4
4	0301008000	Unterlegscheibe	Washer - M8	4
5	4820305020	Hinterrad	Wheel Assembly	2
6	5310213010	Lager	WEIBANG Bearing	10
7	5310211010	Scheibe	Spring Washer - M12.7	4
8	5310210010/02	Scheibe	Plain Washer - M12.7	4
9	4520308010	Staubschutz	Rear Wheel Shield	2
10	0202006000	Sicherungsmutter	Lock Nut - M6	1
11	4510303010/40	Höheneinstellhebel	adjustment lever	1
12	0101006014	Bolzen	Bolt - M6x14	1
13	4520301010/01	Hinterachse	Rear Axle	1
14	Y204520P	Getriebe	Rear Transmission Assembly	1
16	5020308020	Riemenscheibe	Gearbox Pulley	1
17	0701005020	Federstift	Pin - 5x20	1
18	HQ000100060	Stift	Pin For Ratchet - 5x14.5	2
19	5320328010	Nylon Lager	Nylon Ball Bearing	2
20	4520313010/02	Buchse	Rear Transmission Partition	1
21	1001020000	Sicherungsring	Circlip - M12	2
22	Y065321	Lager	Bearing sleeve assembly	2
23	5320327010	Staubdeckung	Dustproof Ring	2
24	5320326010P	Buchse	Bearing	4
25	5320324020/02	Lagerhalter links	Left Bearing Sheath	2
26	HQ000100050	Halter	Ratchet	2
27	1401025015	Ring	O - Ring 25*1.5	2
28	HQ000100040	Feder	Spring	6
29	HQ000100030	Stift	Pin	6
30	HQ000100010	Zahnrad (links)	Drive Pinion - L/H	1
31	HQ000100020	Zahnrad (rechts)	Drive Pinion - R/H	1
32	R8-2RS	Kugellager	Bearing	2
33	5020311010/04	Scheibe	Washer	2
34	1301009000	Sicherungsring	Clip 9	2
35	4520312010	Feder	Spring Of Gearbox	1
36	4510311010/01	Feder	Spring - Connecting Rod	1
37	4510310020/40	Verbindungsstange	Connecting Rod	1
38	0301010000	Scheibe	Plain Washer - M10	2
39	5320333010	Federsplint	Spring Clip	2
40	4520201010/01	Vorderachse	Front Axle	1
41	5310209010	Lager	Spherical Bearing	4
42	4510210010	Vorderrad	Wheel	2

Model:WB455SC-OP
Service code:W455SC-OP2000
Handle and Grass catcher

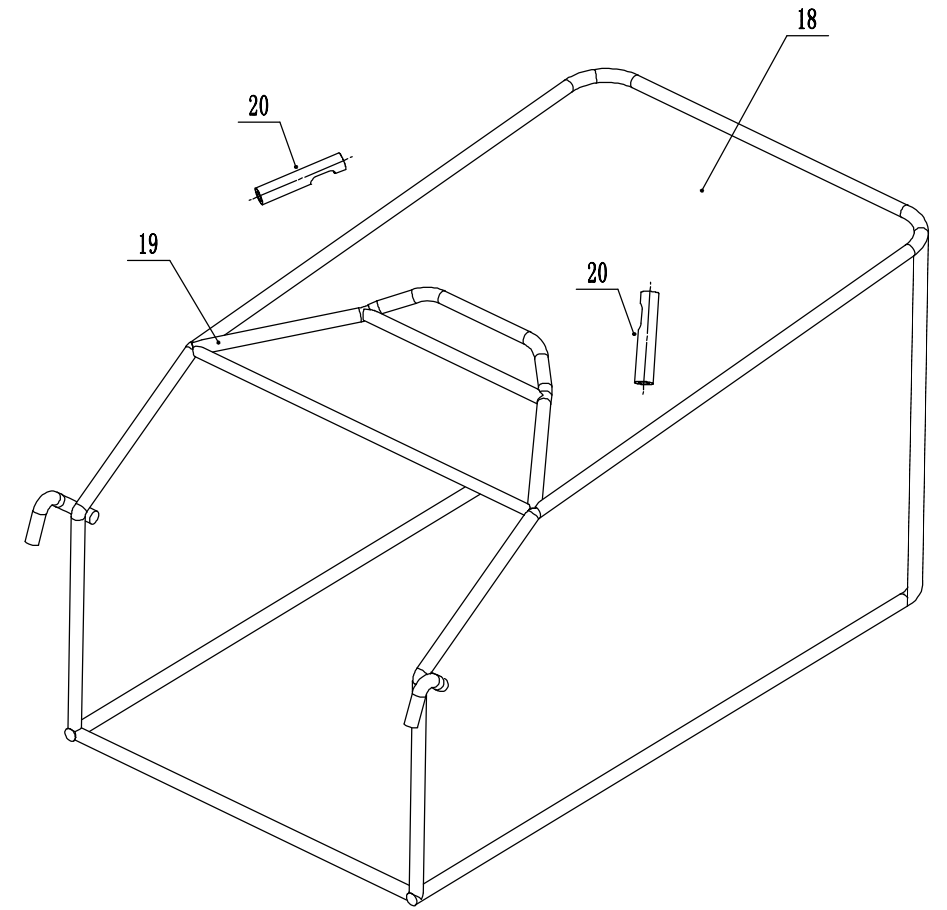
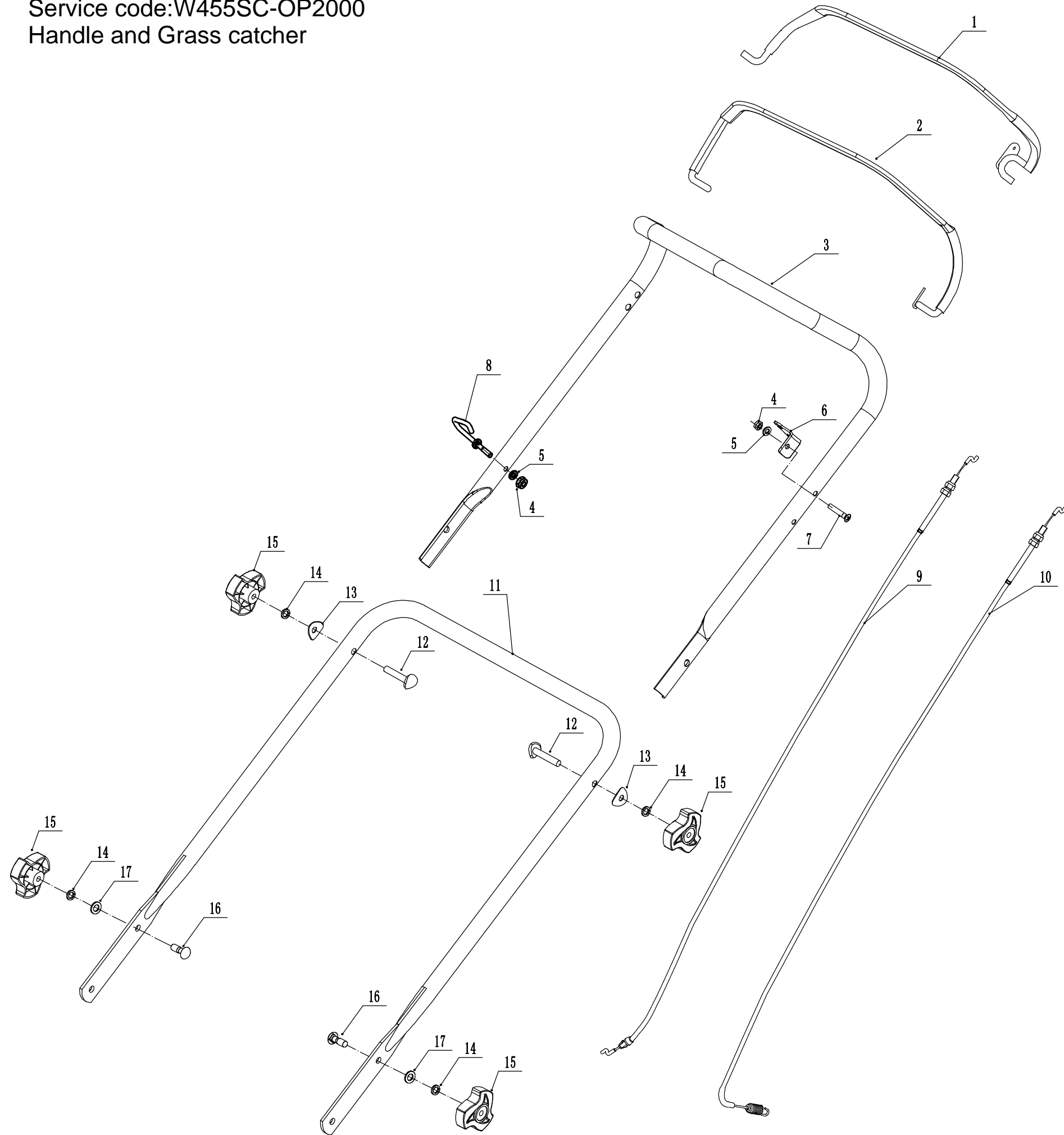

3	2025	WB 455 SC-OP		Ersatzteilliste
Nr.	Ersatzteilnummer	Bezeichnung Deutsch	Bezeichnung Englisch	Anzahl
1	GM38A050100000/40	Motorstopgriff	OPC Lever	1
2	4520510012/40	Kupplungshebel	Clutch Lever	1
3	GM38A050000020/49	Oberer Holm	Upper handle	1
4	0202006000	Sicherungsmutter	Lock Nut - M6	2
5	0301006000	Scheibe	Flat washer - $\phi 6$	1
6	GM46B050000010/01	Klammer	Bracket	1
7	0108006035	Schraube	Screw - M6x35	1
8	4510511010/01	Kabelhalter	Hook - Starter Rope	1
9	BS120-1230	Bremskabel	Brake Cable	1
10	LH194-1195	Kupplungskabel	Clutch Cable	1
11	4510502020/49	Unterer Holm	Lower Handle	1
12	5310510010/01	Schraube	Bolt	2
13	4510510010/01	Scheibe	Arc Washer	2
14	0401008000	Federscheibe	Spring Washer	4
15	4820541010/80	Drehgriff (rot)	Knob	4
16	4510513010/02	Bolzen	Bolt	2
17	0301008000	Unterlegscheibe	Flat washer - $\phi 8$	2
18	4510603060/84	Fangsack	Grass Bag	1
19	4510602030/22	Gestell	Frame	1
20	4510602050	Gummischutz	Frame Sleeve	2