

Model:WB486SC AL V
Service Code:W486VC100B2011
Main Body

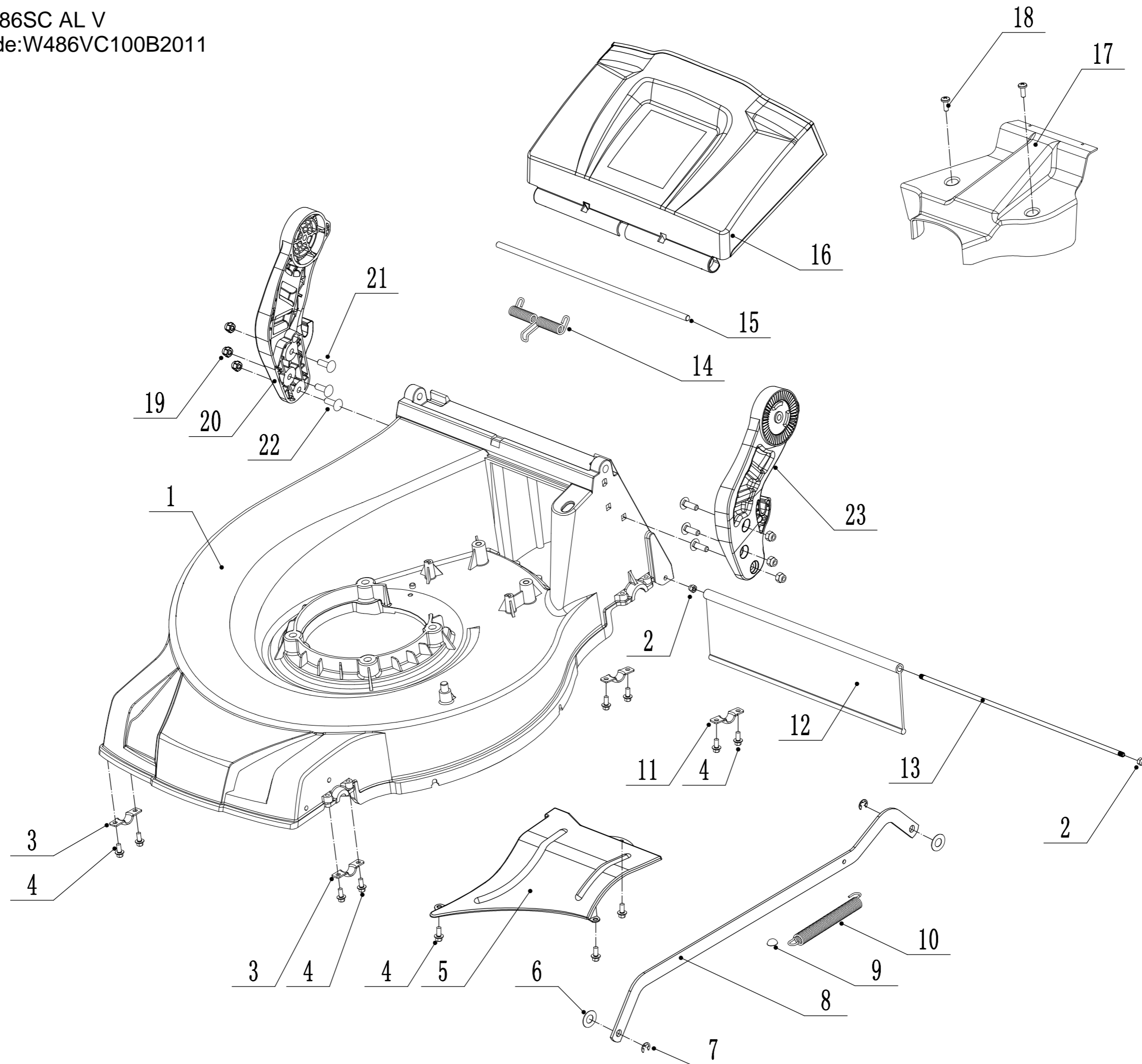

2	Ersatzteilliste WB 486 SC AL V			2023
Nr.	Ersatzteilnummer	Bezeichnung Deutsch	Bezeichnung Englisch	Anzahl
1	4860101010/49	Gehäuse	Chassis	1
2	0202006000	Sechskant Sicherungsmutter	Lock Nut - M6	17
3	4820208010/01	Klammer	Front Bearing Bracket	2
4	4820104010	Schraube	Screw - M6x12	11
5	4820103010/49	Umlenklech	Lower Baffle	1
6	4820306013	Nylon Scheibe	Nylon Mat	2
7	1301008000	Sicherungsring	E-Clip - 8mm	2
8	4860304010/40	Verbindungsstange	Connecting Rod	1
9	4820307011	Sicherrungsring	Domed Grip Washer	1
10	4820307010/01	Feder	Spring - Connecting Rod	1
11	5320114020/01	Halter	Upper Bearing Bracket	2
12	4510111030	Schutz	Trailing Flap	1
13	5020117010/02	Stange	Pivot - Trailing Flap	1
14	4860106010	Feder	Spring - Rear Cover	1
15	4860105010/01	Stange	Pivot - Rear Cover	1
16	4860104010	Abdeckung	Rear Cover	1
17	4860103010	Abdeckung	Upper Belt Shield	1
18	4820122010	Innensechskant Lochschraube	Screw - M6x12	2
19	0202008000	Sicherungsmutter	Lock Nut - M8	6
20	GM48S000000080/40	AVS Halter rechts	AVS Bracket - R/H	1
21	4510513010/01	Bolzen	Bolt - M8x25	2
22	4510513020/01	Bolzen	Bolt - M8x20	4
23	GM48S000000070/40	AVS Halter links	AVS Bracket - L/H	1

Model:WB486SC AL V
Service Code:W486VC100B2011
Blade System

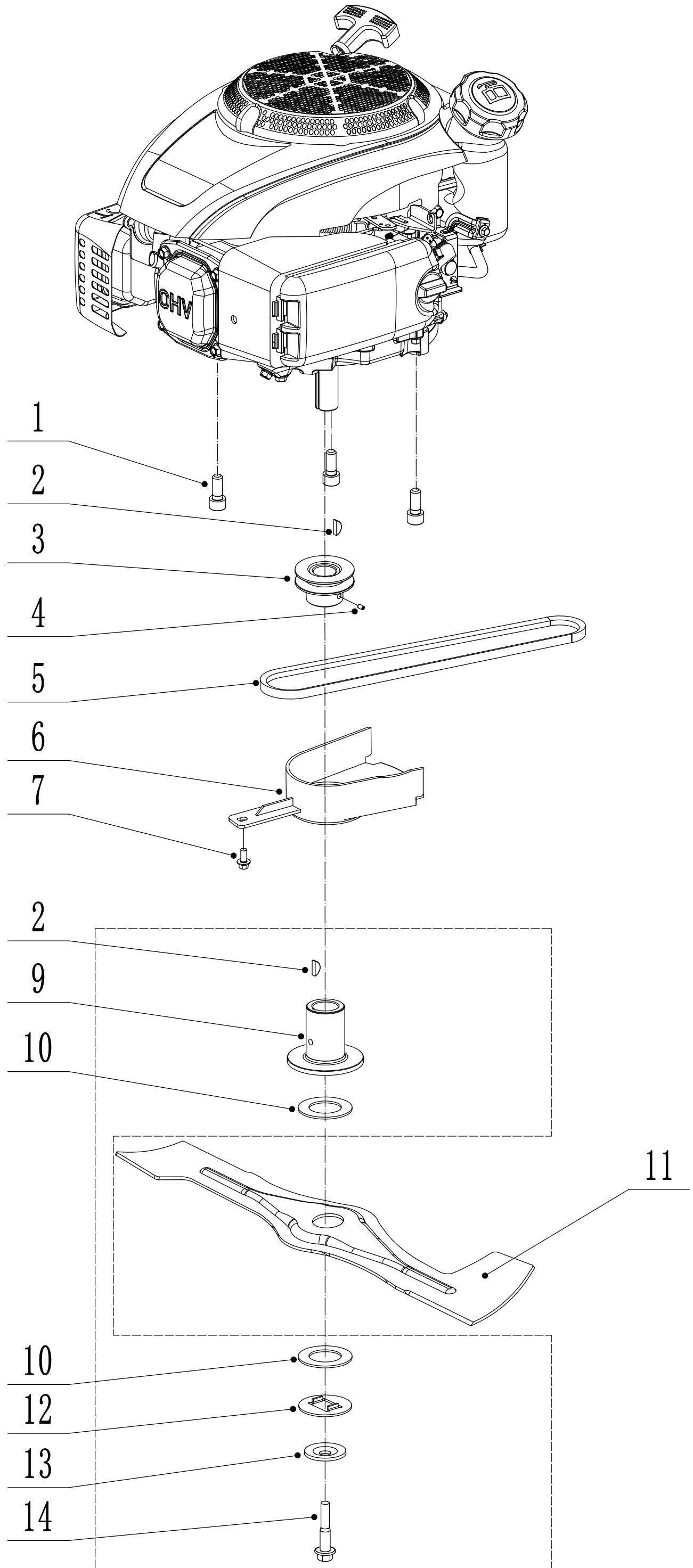

3	Ersatzteilliste WB 486 SC AL V			2023
Nr.	Ersatzteilnummer	Bezeichnung Deutsch	Bezeichnung Englisch	Anzahl
1	4820102010	Schraube	Screw - 3/8x16x28	4
2	5310401010	Keil	Key - B4.7x15.7	2
3	5380402010	Motorriemenscheibe	Engine Pulley	1
4	0105006006	Lochschraube	Screw - M6x6	1
5	5320112010S	Keilriemen	Belt - V10x795 30°	1
6	4820402011	Schild	Belt Shield	1
7	4820104010	Schraube	Screw - M6x12	1
9	5330402010/02	Messerbock	Adaptor	1
10	5310402010	Friktionsscheibe	Friction Disc	2
11	4820403010A	Messer	Blade	1
12	5310404010/02	Ring	Locking Disc	1
13	5310406010/04	Scheibe	Dish Washer	1
14	5310415010	Messerbolzen	Blade Bolt - 3/8x24x40	1

Model:WB486SC AL V
Service Code:W486VC100B2011
Front Axle

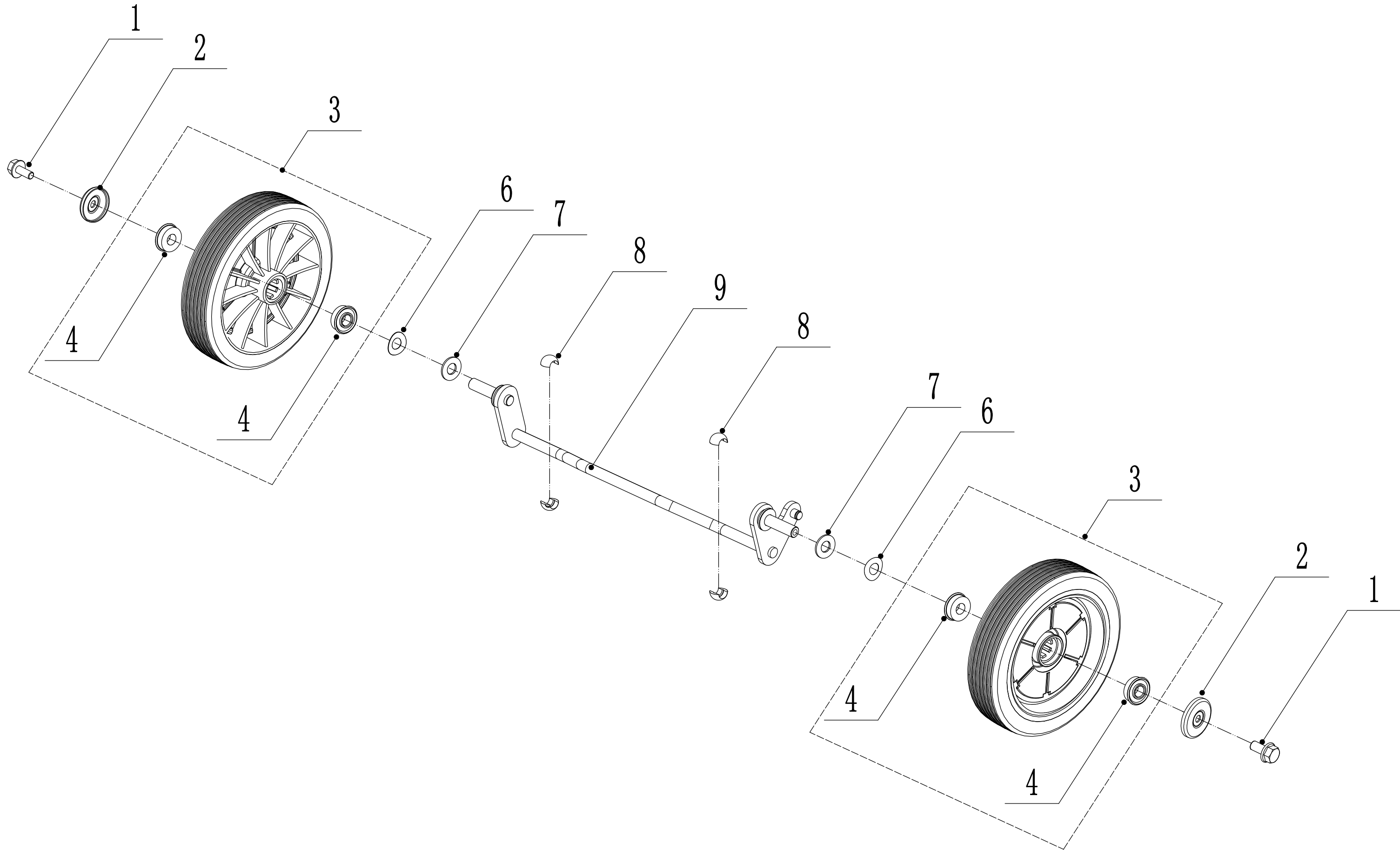

4	Ersatzteilliste WB 486 SC AL V			2023
Nr.	Ersatzteilnummer	Bezeichnung Deutsch	Bezeichnung Englisch	Anzahl
1	0102008016	Bolzen	Bolt - M8x16	2
2	48R0210012/01	Abdeckscheibe	Wheel Cap	2
3	5380205010/40	Rad	Wheel Assembly	2
4	5310213010	Lager	Bearing	4
6	5310211010/02	Federscheibe	Spring Washer - M12.7	2
7	5310210010/02	Scheibe	Plain Washer - M12.7	2
8	5310209010	Lager	Bearing Holder	4
9	4820201010/01	Radachse (vorn)	Front Axle Welding	1

Model:WB486SC AL V
Service Code:W486VC100B2011
Rear Axle

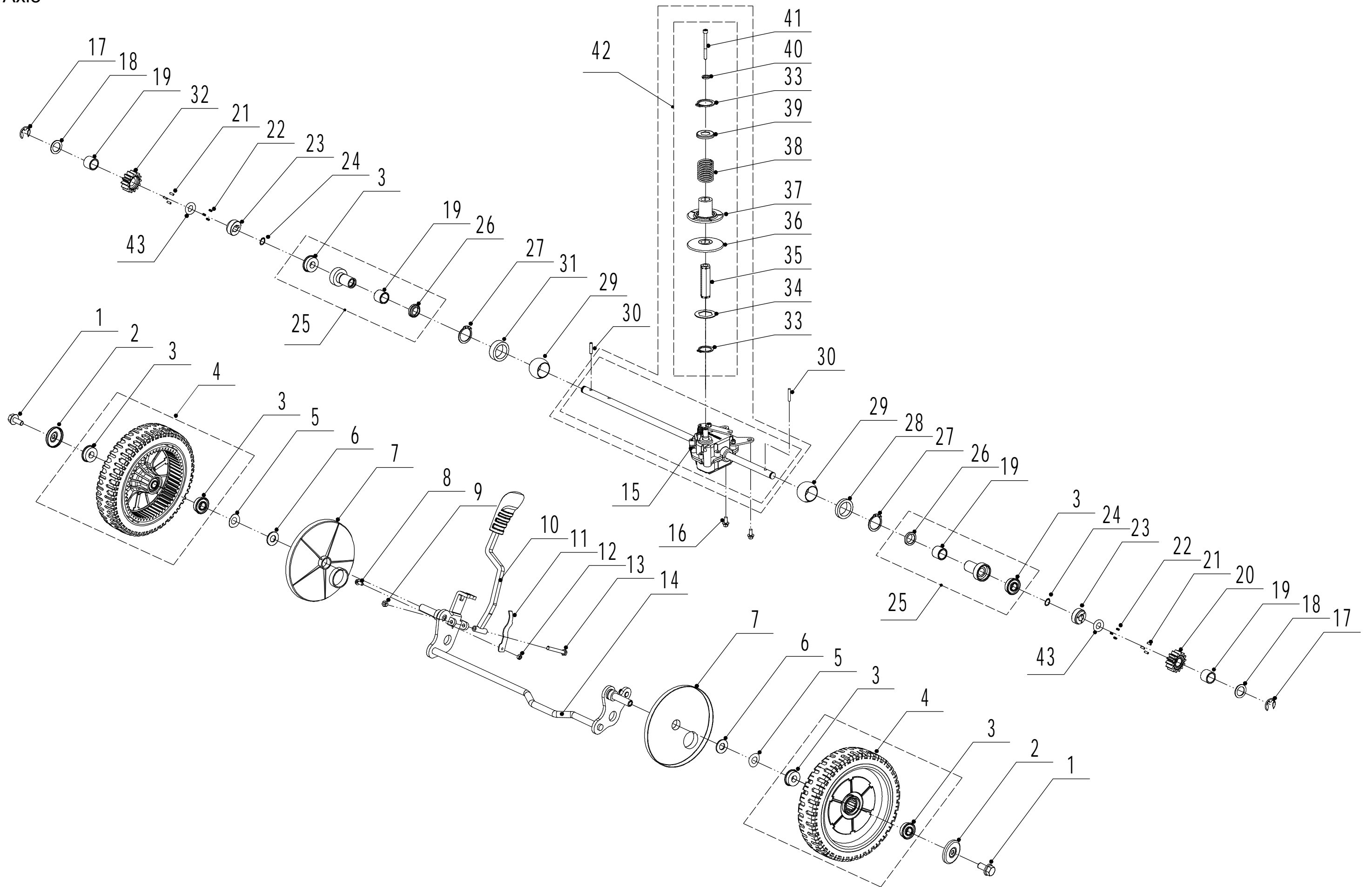

5	Ersatzteilliste WB 486 SC AL V			2023
Nr.	Ersatzteilnummer	Bezeichnung Deutsch	Bezeichnung Englisch	Anzahl
1	0102008016	Bolzen	Bolt - M8x16	2
2	48R0210012/01	Abdeckscheibe	Wheel Cap	2
3	5310213010	Lager	Bearing	6
4	4820305011/40	Rad	Wheel Assembly	2
5	5310211010/02	Federscheibe	Spring Washer - M12.7	2
6	5310210010/02	Scheibe	Plain Washer - M12.7	2
7	4520308010	Rad Abdeckung	Rear Wheel Shield	2
8	0101005016	Bolzen	Bolt - M5x16	1
9	0202006000	Sechskant Sicherungsmutter	Lock Nut - M6	1
10	5380311010/40	Höheneinstellung	Height Adjustment	1
11	5380314010/04	Feder	Spring	1
12	0202005000	Sicherungsmutter	Lock Nut - M5	1
13	0101006055	Bolzen	Bolt- M6x55	1
14	4860301010/01	Hinterachse	Rear Axle Welding	1
15	Y20486V0P	Getriebe	486 Rear Transmission	1
16	4820104010	Schraube	Screw - M6x12	2
17	1301009000	Sicherungsring	E-Clip - M9	2
18	5020311010/04	Scheibe	Washer	2
19	5320326010P	Buchse	Bearing	4
20	HQ000100010	Zahnrad (links)	Drive Pinion - L/H	1
21	HQ000100030	Stift	Pin - Drive Pinion	6
22	HQ000100040	Feder	Spring - Drive Pinion	6
23	HQ000100050	Halter	Block - Drive Pinion	2
24	1001012000	Ring	Circlip - M12	2
25	Y065320	Lager	Bearing Sheath Assembly	2
26	5320327010	Staubabdeckung	Dustproof Ring	2
27	1001020000	Sicherungsring für Welle	Circlip - M20	2
28	4820326010/02	Scheibe	Bearing Bracket Left Washer	1
29	5320328010	Nylon Lager	Nylon Ball Bearing	2
30	HQ000100060	Stift	Check Holder	2
31	5320329010/02	Buchse	Rear Axle Partition	1
32	HQ000100020	Zahnrad (rechts)	Drive Pinion - R/H	1
33	1001017000	Sicherungsring	Circlip - M17	2
34	4820320010/02	Scheibe	Inner Hex Washer	1
35	4820321010/02	Schutz	Hex Adapter	1
36	5380309010	Scheibe	Lower Pulley disc	1
37	5380308010	Variatorhälfte	Active Pulley Disc	1
38	4820324010	Feder	Spring	1
39	4820325010/02	Federschutz	Spring Cap	1
40	0401005000	Scheibe	Spring Washer-M5	1
41	0103005055	Innensechskantschraube	Bolt - M5x55	1
42	Y115380	Ring	Speed Variator Assembly	1

43	1401025015	Ring	O-Ring	2
----	------------	------	--------	---

Model:WB486SC AL V
Service Code:W486VC100B2011
Handle and Controls

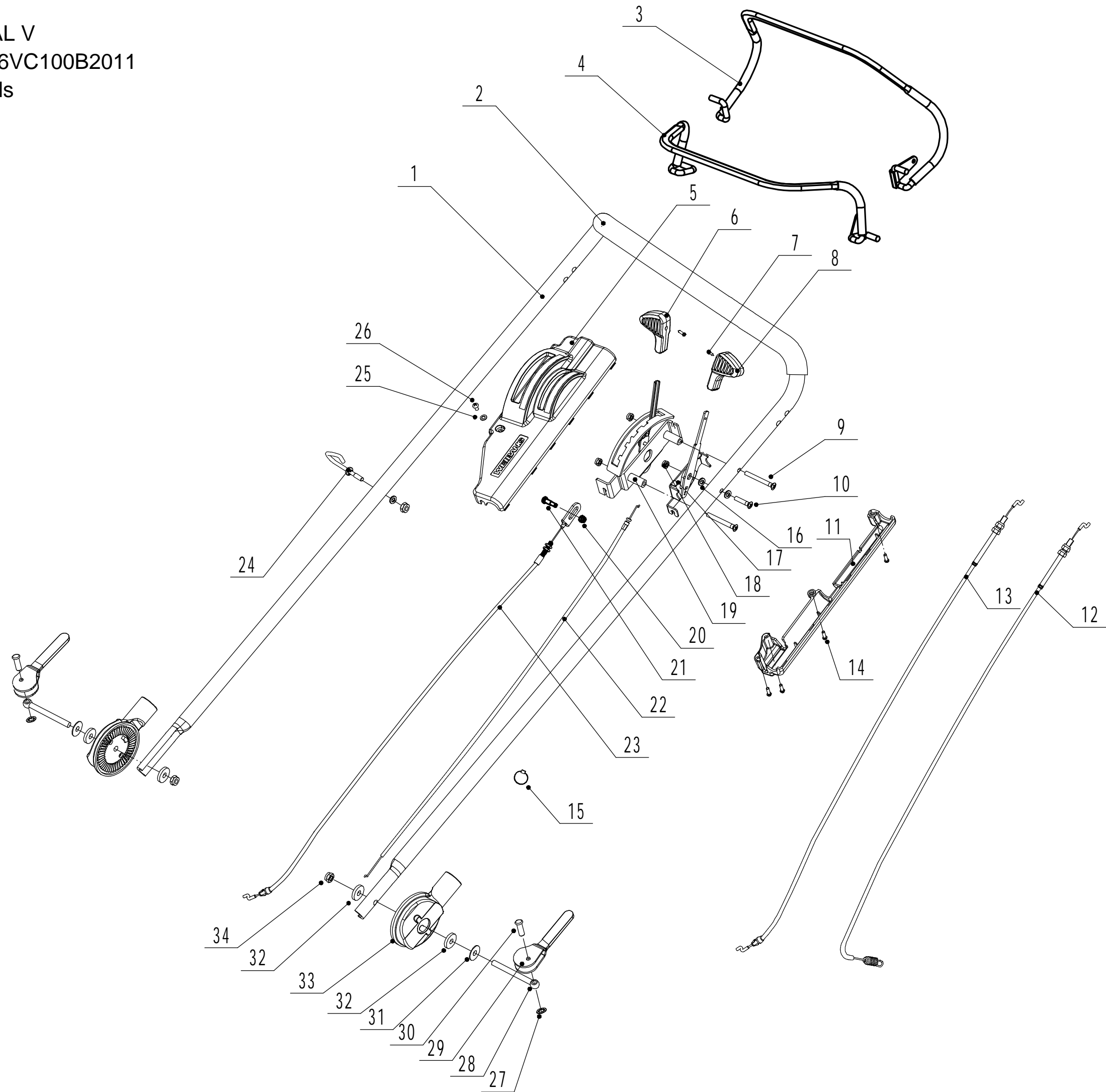

6	Ersatzteilliste		WB 486 SC AL V	2023
Nr.	Ersatzteilnummer	Bezeichnung Deutsch	Bezeichnung Englisch	Anzahl
1	5020501020S/49	Griff	Handle	1
2	GM56E010000080	Gummischutz	Handle Sheath	1
3	5320511030S/49	Griff	Clutch Lever Weldment	1
4	5320503020S/49	Griff	Brake Lever Weldment	1
5	5020501030S	Schutz	Control Box Upper Cover	1
6	5380508010	Knopf	Speed Control Grip	1
7	0106003013	Schraube	Screw - ST2.9x13	2
8	5380510010	Kappe für Gasgriff	Throttle Grip	1
9	0108006060	Schraube	Screw - M6x60	2
10	0108006050	Schraube	Screw - M6x50	1
11	5020501040S	Schutz	Control Box Lower Cover	1
12	LH194-1195	Kupplungskabel	Brake Cable	1
13	BS120-1140	Motorbremszug	Clutch Calbe	1
14	0113040018	Schraube	Screw	4
15	ZD3/190	Ring	Cable Ties	1
16	0301006000	Scheibe	Spacer	8
17	5380512010	Hebel	Throttle Bracket	1
18	202006000	Sechskant Sicherungsmutter	Lock Nut	3
19	5360505010K	Geschwindigkeitsregulierung	Speed Control Bracket	1
20	0202005000	Sicherungsmutter	Lock Nut	1
21	5360506011	Schraube	Speed Control Cable Bolt	1
22	YM72-970-A	Gaszug	Throttle Cable	1
23	TX123-1055-B	Geschwindigkeitsbowdenzug	Speed Control Cable	1
24	4510511010/01	Kabelhalter	Hook	1
25	0301005000	Unterlegscheibe	Flat Washer	1
26	0104005008	Bolzen	Screw - M5x8	1
27	4510114030	Buchse	Fix Cap	2
28	GM48S000000100	Bolzen	Connecting Bolt	2
29	GM56A100400000	Hebel	Lock Lever	2
30	0801008025	Stift	Axis Pin - 8x22	2
31	GM56A100000040/04	Scheibe	Spacer	2
32	GM56A100000050/01	Scheibe	Spacer	4
33	GM48S030200000	Verstellsegment	Tooth Disc Kit	2
34	0201008000DD	Mutter	Lock Nut - M8	2

Model:WB486SC AL V
Service Code:W486VC100B2011
Grass Catcher

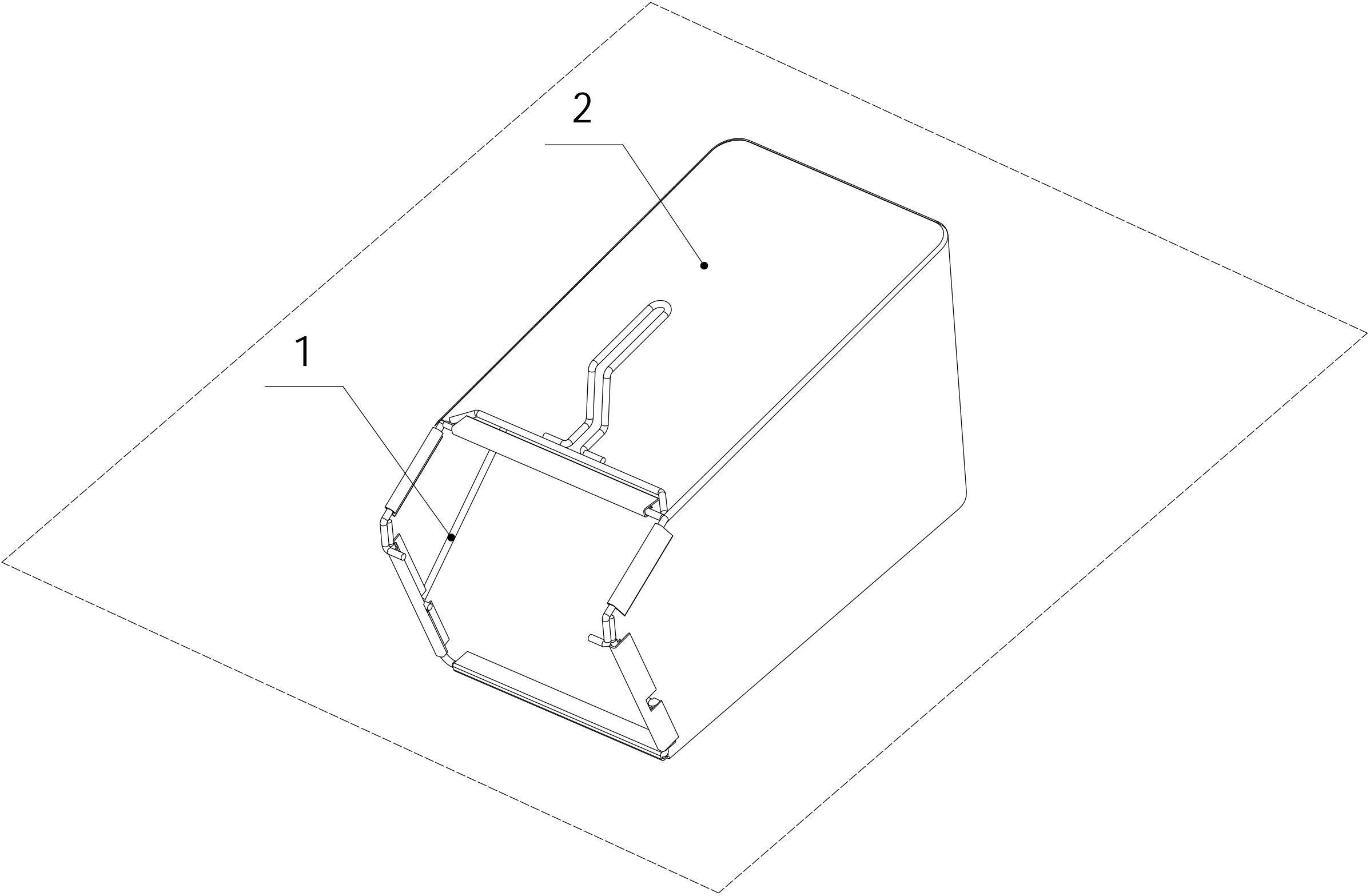

7	Ersatzteilliste		WB 486 SC AL V	2023
Nr.	Ersatzteilnummer	Bezeichnung Deutsch	Bezeichnung Englisch	Anzahl
1	4860602010S/22	Gestell	Grass Bag Frame	1
2	4820611010S/84	Fangsack	Grass Bag	1

Model:WB486SC AL V
Service Code:W486VC100B2011
Belt Tensioner

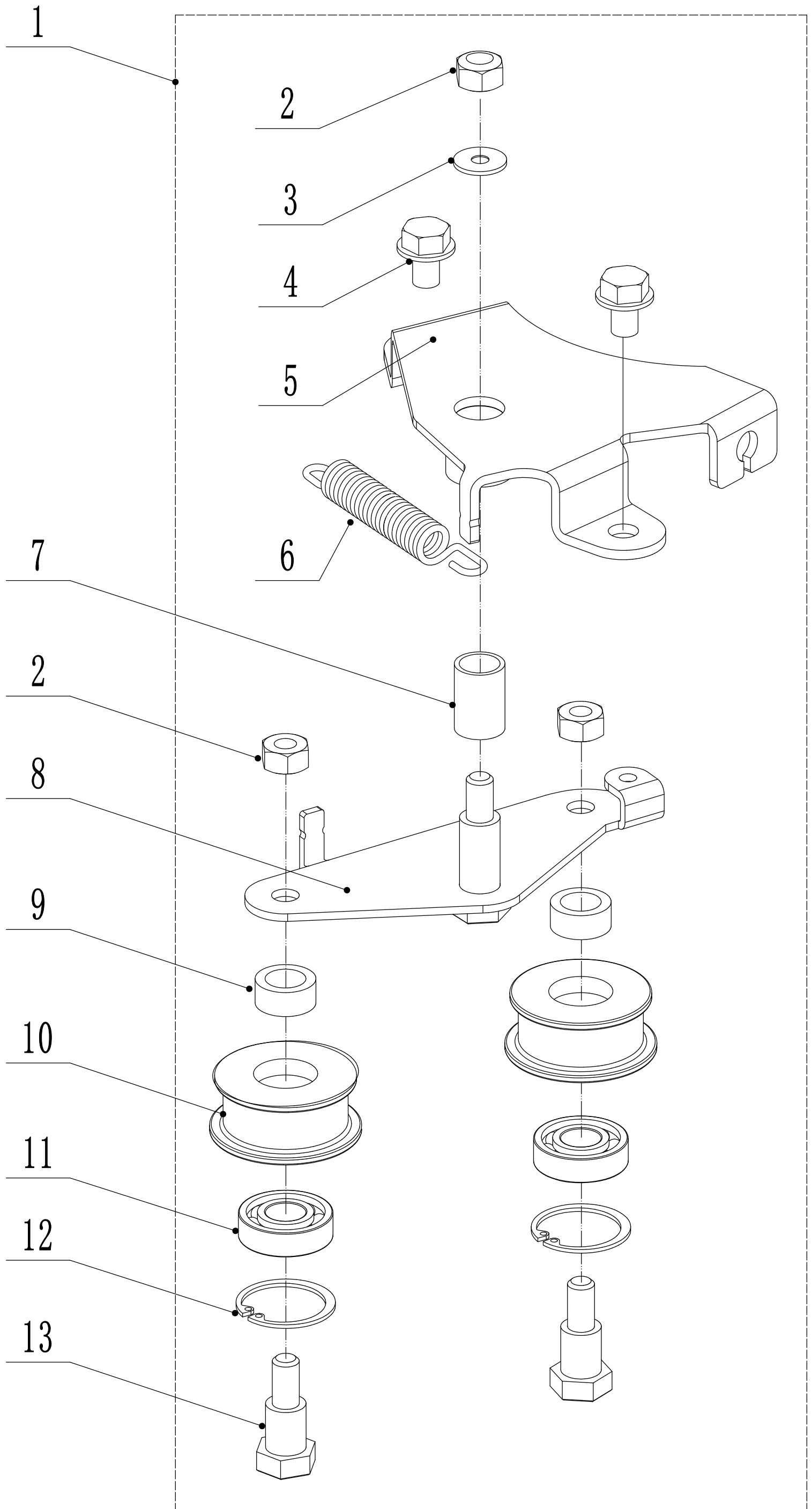

8	Ersatzteilliste WB 486 SC AL V			2023
Nr.	Ersatzteilnummer	Bezeichnung Deutsch	Bezeichnung Englisch	Anzahl
1	Y094820	Keilriemenspannung komplett	Belt Tensioner Assembly	1
2	0202008000	Sicherungsmutter	Lock Nut - M8	3
3	0302008000	Unterlegscheibe	Washer - M8	1
4	4820113010	Bolzen	Screw-5/16x18x14	2
5	4820109010/02	Halterung	Tensional Arm Bracket	1
6	4820114010	Feder	Spring	1
7	4820112010	Kunststoffbuchse	Nylon Bush	1
8	4820115010/02	Halter	Tensional Arm Weldment	1
9	4820118010/02	Schraube	Spacer	2
10	4820119010	Spannrolle	Tensional Pulley	2
11	6001-2RZ	Kugellager	Bearing	2
12	0901028000	Sicherungsring	Circlip - 28mm	2
13	4820120010	Spannbolzen	Tensional Pulley Bolt	2