

Model:WB487SCV AL

Service Code:W487VC120B1800

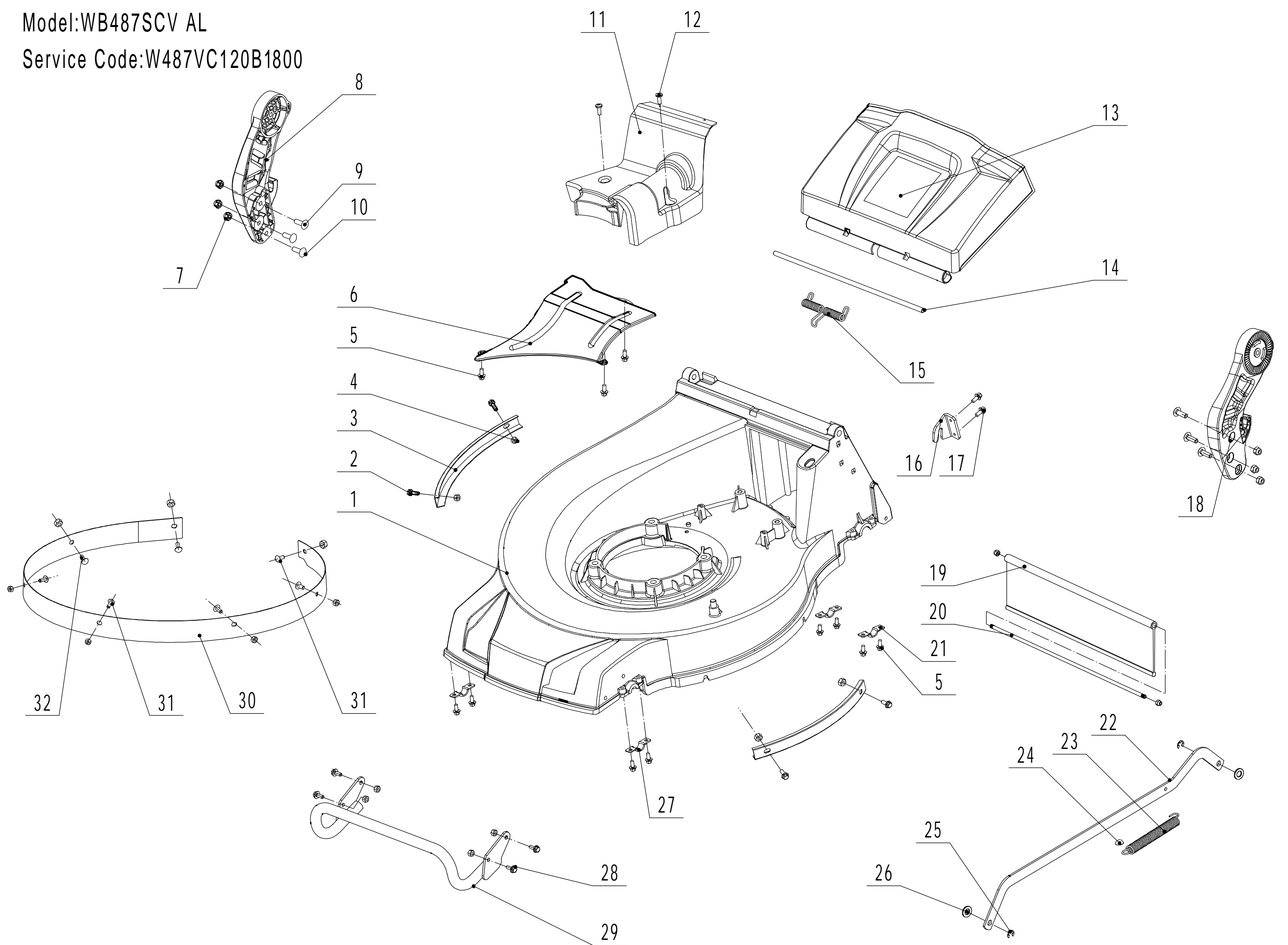

Ersatzteilliste Zeichnung Nummer 2		WB 487 SC V AL		2019
Nummer	Ersatzteilnummer	Deutsche Bezeichnung	Englische Bezeichnung	Menge
1	4860101010S-44	Gehäuse	Chassis	1
2	0102006010	Bolzen	Bolt	4
3	4810103010-40	Schiene	Outside Skirt	2
4	0202006000	Mutter	Lock Nut	17
5	4820104011	Schraube	Screw	11
6	4820103010-49	Blech	Bottom Baffle	1
7	0202008000	Mutter	Lock Nut	6
8	GM48S000000080-40	Rechter Halter	Right Bracket	1
9	0107008025	Bolzen	Bolt	2
10	0102008020	Bolzen	Bolt	4
11	GM48S000000020	Riemenschutz	Belt Shield	1
12	4820122010	Schraube	Screw	2
13	4860104010	Abdeckung	Rear Cover	1
14	4860105010-01	Stange	Pivot	1
15	48601106010	Feder	Spring	1
16	GM53C000000050-02	Halter	Location Bracket	1
17	0102006012	Bolzen	Bolt	2
18	GM48S000000070-40	Linker Halter	Left Bracket	1
19	4510111030	Schutz	Trailing Flap	1
20	5020117010-02	Stange	Pivot	1
21	5320114020-01	Lagerhalter	Upper Bearing Bracket	2
22	4860304010-40	Verbindungsstange	Connecting Rod	1
23	4820307010	Feder	Spring	1
24	4820104011	Kappe	Fix Cap	1
25	1301008000	Sicherungsring	Check Ring	2
26	4820306013	Scheibe	Nylon Spacer	2
27	4820208010	Lagerhalter	Front Bearing Bracket	2
28	0102006016	Bolzen	Bolt	4
29	4860108010-40	Stoßstange	Bumper	1
30	4860109010-40	Verschleißeinlage	Inner Arc Plate	1
31	0109006016	Schraube	Screw	3
32	0109006014	Schraube	Screw	4

Model:WB487SC V AL

Service Code:W487VC120B1800

Blade Components

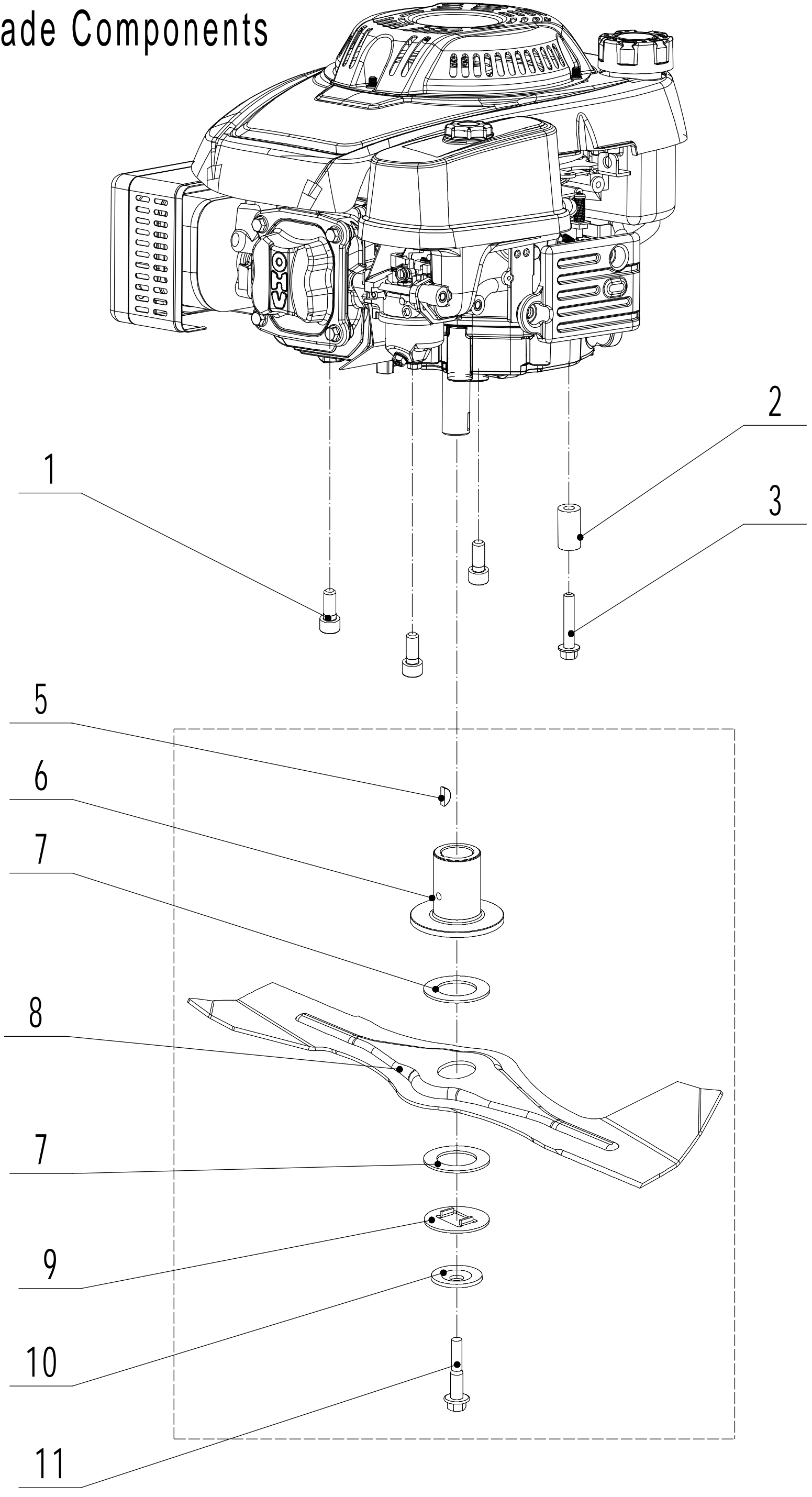

Ersatzteilliste Zeichnung Nummer 3		WB 487 SC V AL		2019
Nummer	Ersatzteilnummer	Deutsche Bezeichnung	Englische Bezeichnung	Menge
1	0103010025	Schraube	Screw	3
2	GM53C000000030-02	Buchse	Bush	1
3	0102008055	Bolzen	Hex Bolt	1
5	4510401010	Keil	Key	1
6	4510402010-02	Messerhalter	Adapter	1
7	5310402010	Friktionsscheibe	Friction Disc	2
8	4860401010-22	Messer	Blade	1
9	5310404010-02	Ring	Locking Disc	1
10	5310406010-04	Federscheibe	Spring Washer	1
11	5310415010	Messerschraube	Central Bolt	1

Model:WB487SC V AL
Service Code:W487VC120B1800
Front Axle

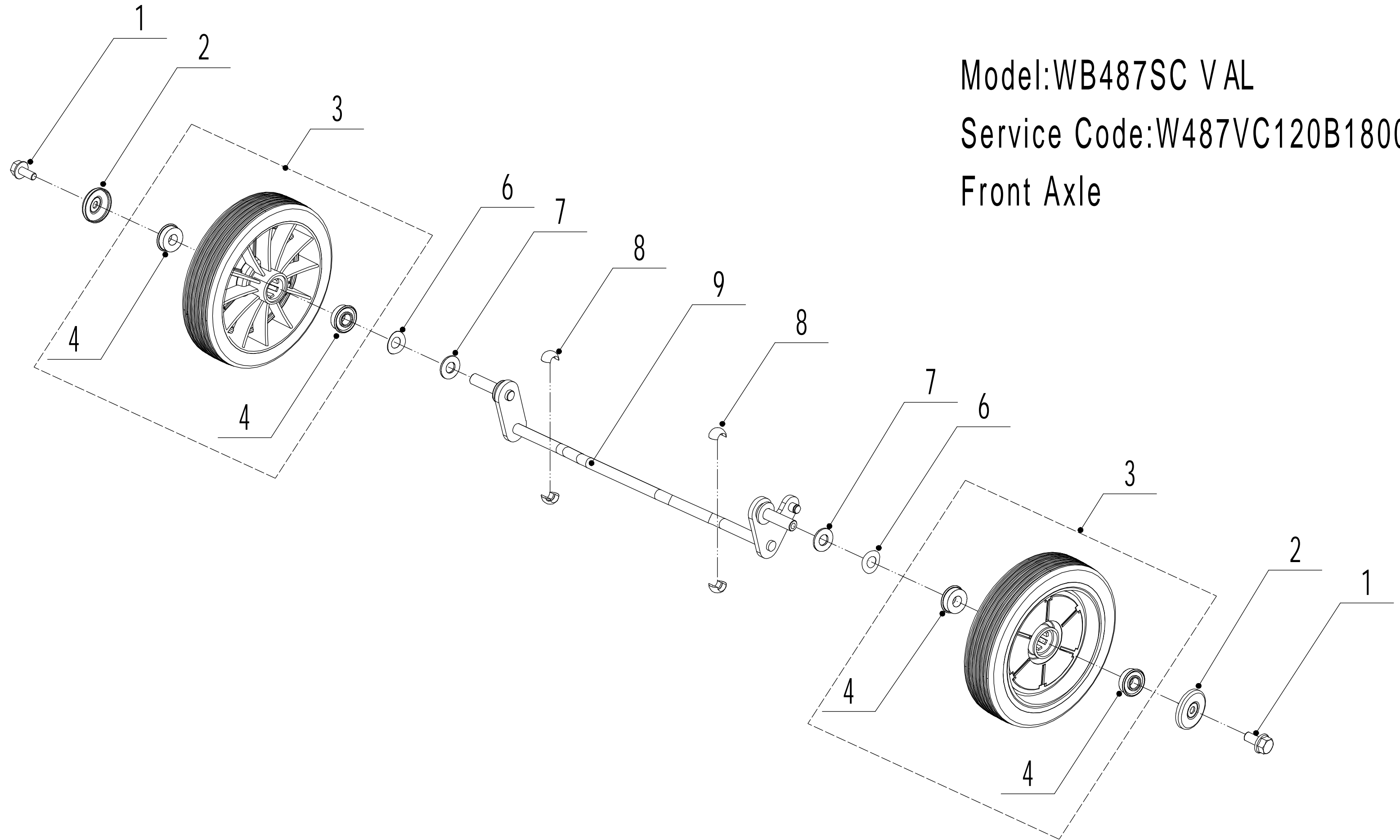

Ersatzteilliste Zeichnung Nummer 4		WB 487 SC V AL		2019
Nummer	Ersatzteilnummer	Deutsche Bezeichnung	Englische Bezeichnung	Menge
1	0101008016	Bolzen	Bolt	2
2	48R0210012-01	Radkappe	Wheel Cap	2
3	5380205010-40	Rad	Wheel	2
4	5310213010	Lager	Bearing	4
6	5310211010-02	Federscheibe	Spring Washer	2
7	5310210010-02	Abstandshalter	Spacer	2
8	5310209010	Lager	Bearing	4
9	4820201010-01	Frontachse	Front Axle	1

Model:WB487SC VAL

Service Code:W487VC120B1800

Rear Axle

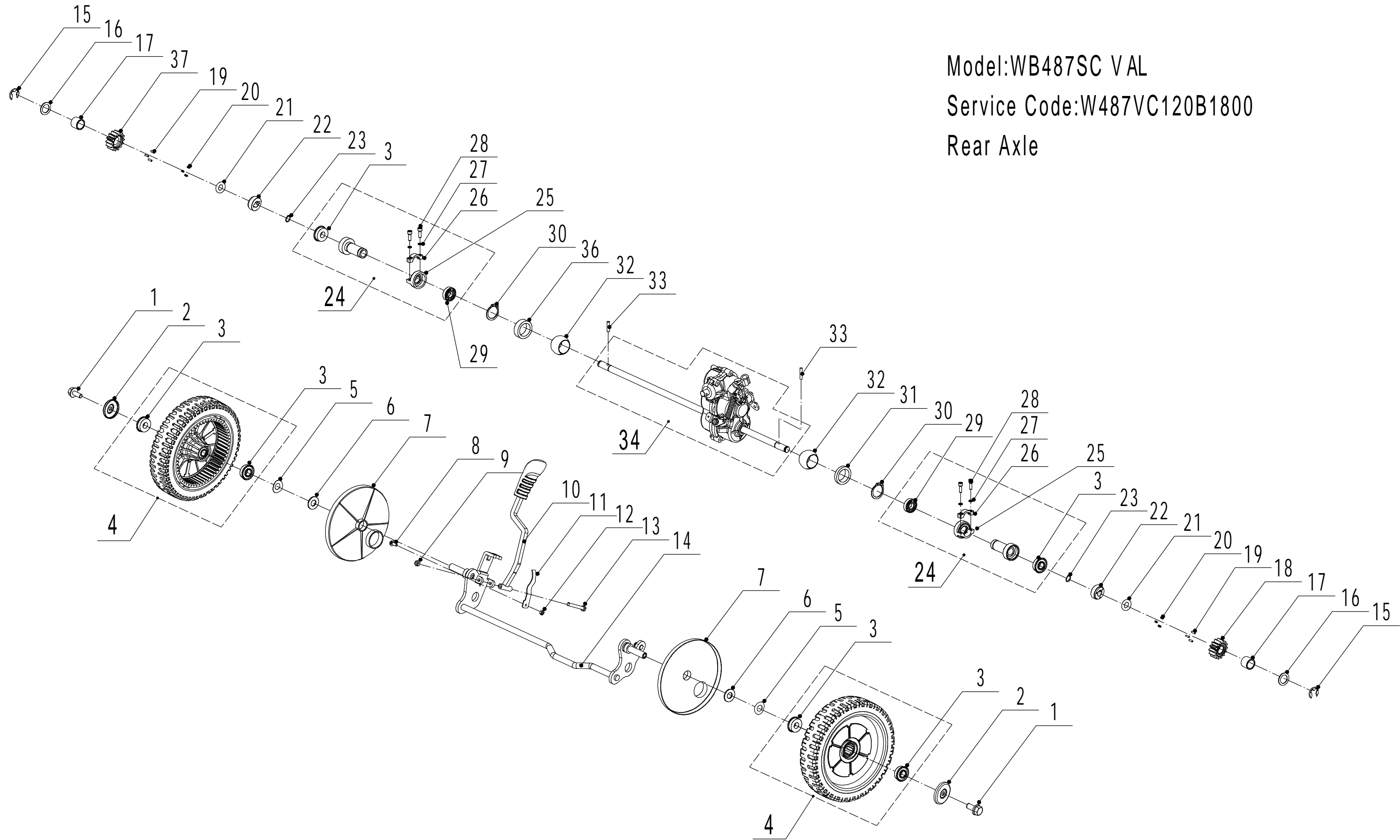

Ersatzteilliste Zeichnung Nummer 5		WB 487 SC V AL		2019
Nummer	Ersatzteilnummer	Deutsche Bezeichnung	Englische Bezeichnung	Menge
1	0102008016	Bolzen	Bolt	2
2	48R0210012-01	Radkappe	Wheel Cap	2
3	5310213010	Lager	Bearing	6
4	4820305011-40	Hinterrad	Rear Wheel	2
5	5310211010-02	Federscheibe	Spring Washer	2
6	5310210010-02	Scheibe	Axle Spacer	2
7	4520308010	Staubabdeckung	Antidust Shield	2
8	0101006015	Bolzen	Bolt	1
9	0202006000	Mutter	Lock Nut	1
10	5380311010-40	Hebel	Lever	1
11	5380314010-04	Feder	Spring	1
12	0202005000	Mutter	Lock Nut	1
13	0101006055	Bolzen	Bolt	1
14	4860301010S-01	Hinterachse	Rear Axle	1
15	1301009000	Sicherungsring	Check Ring	2
16	5020311010-04	Abstandshalter	Spacer	2
17	5320326010P	Lager	Bearing	2
18	HQ000100010	Zahnrad links	Left Drive Pinion	1
19	HQ000100030	Stift	Pin	6
20	HQ000100040	Feder	Spring	6
21	1401025015	Ring	O-Ring	2
22	HQ000100050	Halter	Ratchet	2
23	1001012000	Sicherungsring	Check Ring	2
24	Y065320SF	Lagerhalter	Bearing Sheath	2
25	5320324022	Lagerhalter	Bearing Holder	2
26	5320324023	Lagerabdeckung	Bearing Cover	2
27	0401005000	Federscheibe	Spring Washer	4
28	0103005020A	Schraube	Screw	4
29	R8	Lager	Ball Bearing	2
30	1001020000	Sicherungsring	Check Ring	2
31	4820326010-02	Ring	Left Spacer	1
32	5320328010	Lager	Bearing	2
33	HQ000100060	Stift	Pin	2
34	Y20486Z0	Getriebe	Gearbox	1
36	5320329010-02	Hülse	Partition	1
37	HQ000100020	Zahnrad rechts	Right Drive Pinion	1

Model:WB487SC V AL
Service Code:W487VC120B1800
Handle And Controls

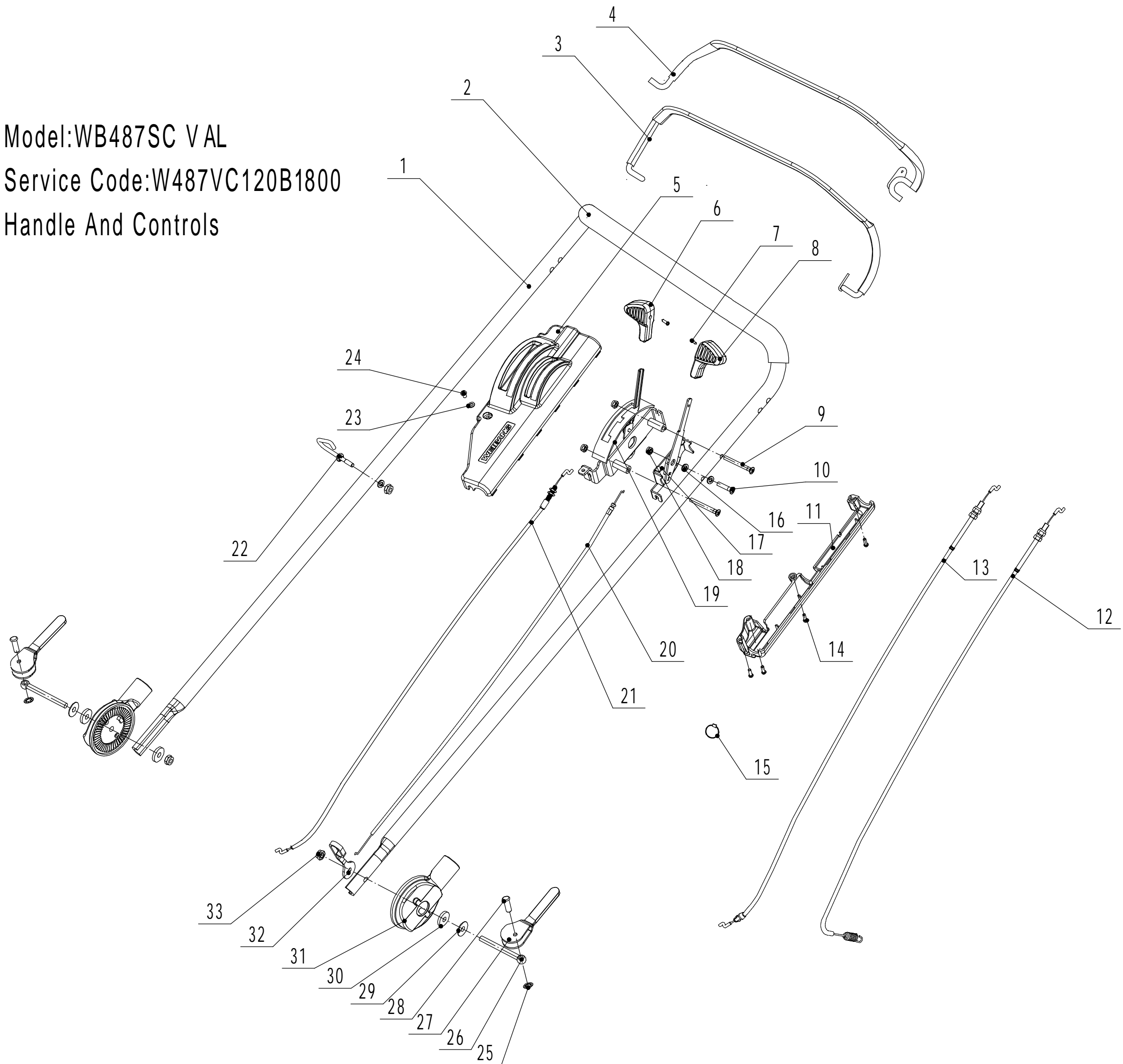

Ersatzteilliste Zeichnung Nummer 6		WB 487 SC V AL		2019
Nummer	Ersatzteilnummer	Deutsche Bezeichnung	Englische Bezeichnung	Menge
1	5020501020S-44	Holm	Handle	1
2	GM56E010000080	Gummischutz	Handle Sheath	1
3	5320511030S-40	Kupplungshebel	Clutch Lever	1
4	5320503020S-40	Bremshebel	Brake Lever	1
5	5020501030S	Kabelboxhälfte	Upper Cover	1
6	5380508010	Knopf	Speed Adjustment Grip	1
7	0106003013	Schraube	Screw	2
8	5380510010-80	Knopf	Throttle Grip	1
9	0108006060	Schraube	Screw	2
10	0108006050	Schraube	Screw	1
11	5020501040S	Kabelboxhälfte	Lower Cover	1
12	LH180-1130-S	Kupplungskabel	Clutch Cable	1
13	BS120-1090	Bremskabel	Brake Cable	1
14	0113040018	Schraube	Screw	4
15	ZD3-190	Kabelhalter	Tie	1
16	0301006000	Abstandshalter	Spacer	3
17	5380512010	Gashebel	Throttle Bracket	1
18	0202006000	Mutter	Lock Nut	4
19	5020501050S	Hebel	Bracket	1
20	YM72-1060-A	Gaszug	Throttle Cable	1
21	TX120-970-S	Fahrgeschwindigkeitszug	Speed Control Cable	1
22	4510511010-01	Haken	Hook	1
23	0301005000	Scheibe	Spacer	1
24	0104005008	Schraube	Screw	1
25	4510114030	Kappe	Fix Cap	2
26	GM48S000000100	Bolzen	Bolt	2
27	GM56A100400000	Hebel	Lock Lever	2
28	0801008022	Stift	Axis Pin	2
29	GM56A100000040-04	Abstandshalter	Spacer	2
30	GM56A100000050-01	Scheibe	Spacer	3
31	GM48S030200000	Verstellsegment	Tooth Disc Kit	2
32	GM48S000000090-01	Clip	Clip	1
33	0201008000DD	Mutter	Lock Nut	2

Model:W487SC V AL

Service Code:W487VC120B1800

Grass Catcher

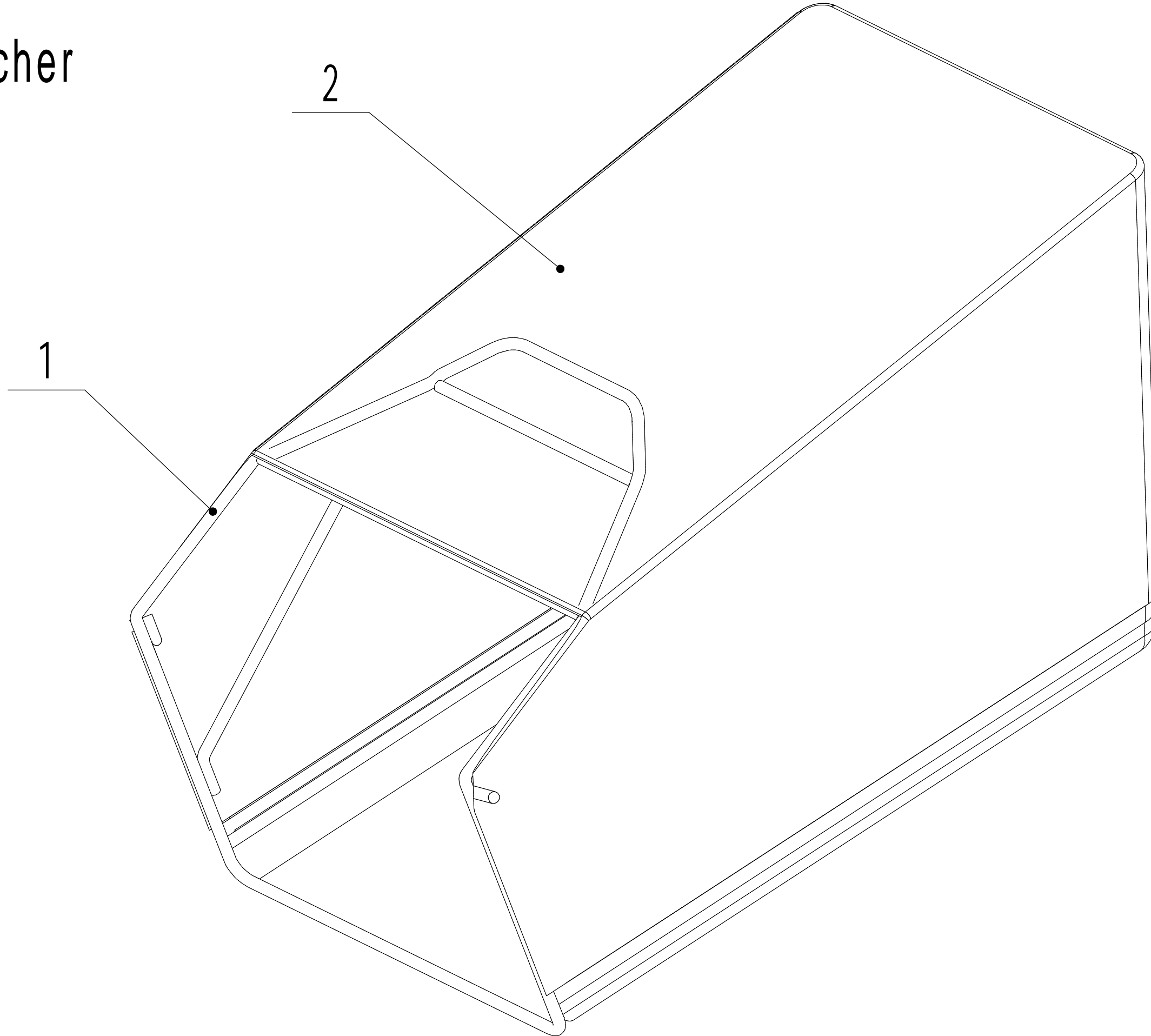

Ersatzteilliste Zeichnung Nummer 7		WB 487 SC V AL		2019
Nummer	Ersatzteilnummer	Deutsche Bezeichnung	Englische Bezeichnung	Menge
1	4860602010S-22	Gestell	Frame	1
2	4820611010S-84	Fangsack	Grass Bag	1

Model:WB487SC VAL

Service Code:W487VC120B1800

Universal Drive Shaft

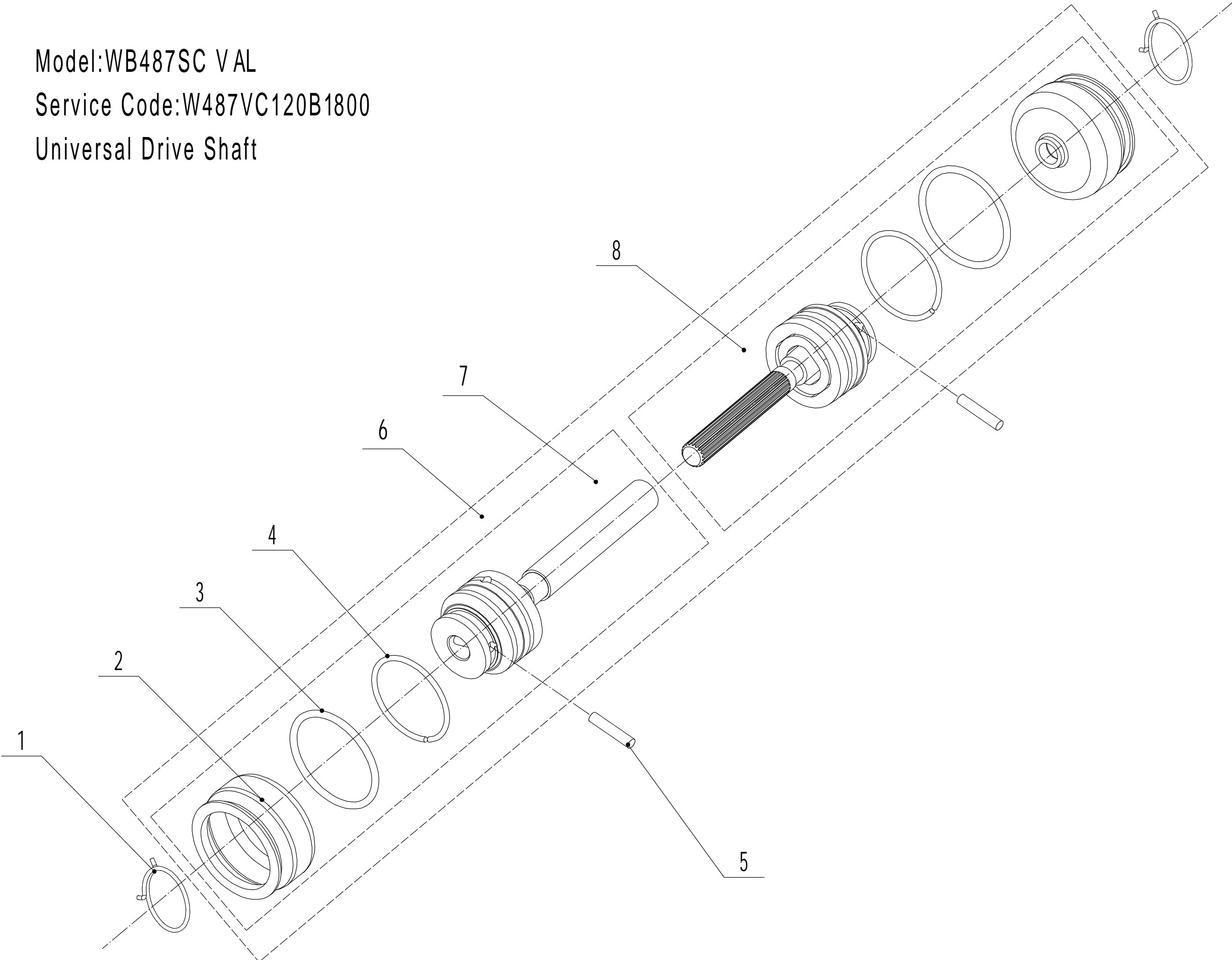

Ersatzteilliste Zeichnung Nummer 8		WB 487 SC V AL		2019
Nummer	Ersatzteilnummer	Deutsche Bezeichnung	Englische Bezeichnung	Menge
1	HQA020000020	Sicherungsring	Check Ring	2
2	HQA020000080	Staubschutz	Antidust Shield	2
3	1401028003	Ring	O-Ring	2
4	HQA020000030	Sicherungsring	Check Ring	2
5	HQA020000090	Stift	Pin	2
6	Y26ZCD03	Kardanantrieb	Universal Drive Shaft	1
7	Y26ZCDA02	Kardanantrieb A	Universal Drive Shaft A	1
8	Y26ZCDB02	Kardanantrieb B	Universal Dive Shaft B	1