

# WB476 SK AL V S GL底盘总成

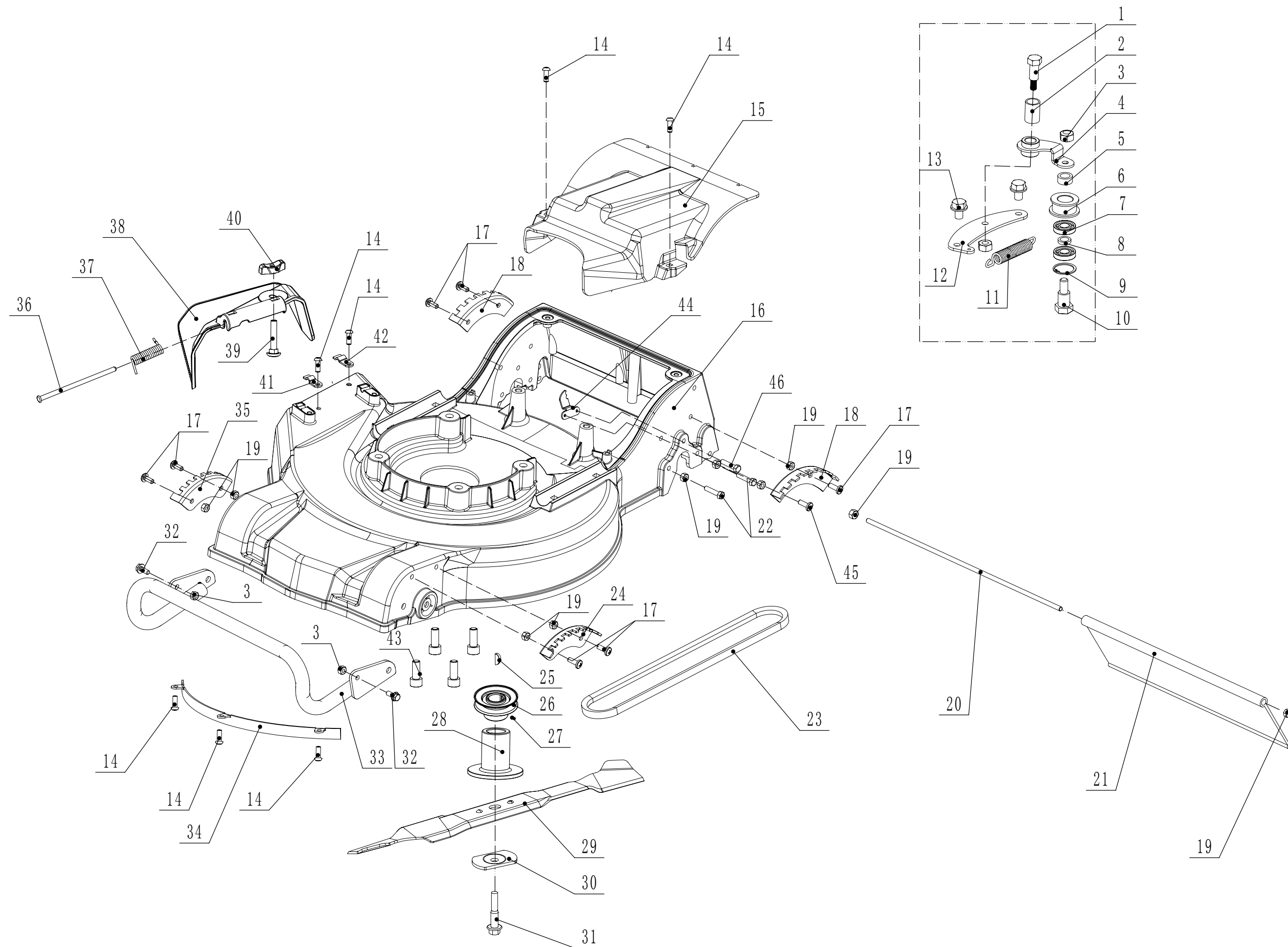

Nr.	Ersatzteilnummer	Bezeichnung Deutsch	Bezeichnung Englisch	Anzahl
1	5340126010/02	Zentralbolzen	bolt	1
2	4820112010	Nylon Klammer	nylon bush	1
3	0202008000	Sicherungsmutter	lock nut	3
4	5340125010/02	Halter	arm weldment	1
5	GM45D060000010	Scheibe	spacer	1
6	5340128010	Riemenscheibe	pulley	1
7	609/2RS	Kugellager	bearing	2
8	5340130010/02	Buchse	spacer	1
9	0901024000	Sicherungsring	check ring	1
10	GM45D060000020	Bolzen	bolt	1
11	5340127010	Splint	spring	1
12	5340124010/02	Platte	plate	1
13	4820113010	Bolzen	bolt	2
14	4820122010	Lochschraube	lock screw	7
15	GM45D000000050	Abdeckung	rear cover	1
16	GM45D000000010/47	Gehäuse	mower deck	1
17	0104006016	Schraube	screw	7
18	GM45D000000040/01	Höhenverstellsegment	graduator	2
19	0202006000	Sicherungsmutter	lock nut	16
20	GM45D000000150/02	Stange	pivot	1
21	GM45D000000140	Schutz	deflector	1
22	0101006025	Bolzen	bolt	5
23	VB46010/750	Keilriemen	belt	1
24	GM45D000000020/01	Höhenverstellsegment	graduator	1
25	4510401010	Keilriemen	key	2
26	4820401020	Motorriemenscheibe	pulley	1
27	0105006006	Lochschraube	lock screw	1
28	GM45D000000260/02	Messerhalter	adapter	1
29	4510404010D/22	Messer	blade	1
30	4510407010/04	Unterlegscheibe	spring washer	1
31	5320405010	Messerbolzen	central bolt	1
32	0102008020	Schraube	bolt	2
33	GM45D010000000/22	Stoßstange	bumper weldment	1
34	GM45D050000000/22	Schutz	deflector	1
35	GM45D000000130/01	Höhenverstellsegment	graduator	1
36	GM45D000000110/02	Achse	axle	1
37	GM45D000000100	Feder	twist spring	1
38	GM45D000000090	Seitenauswurfklappe	deflector	1
39	0107006025	Bolzen	bolt	1
40	GM45D000000080	Flügelmutter	lock nut	1
41	GM45D000000120/02	Platte	plate	1
42	GM45D000000070/02	Platte	plate	1
43	4820102010	Schraube	screw	4
44	GM45D000000290/22	Halter	clip	1
45	0104006020	Schraube	screw	1
46	0101006030	Schraube	bolt	1

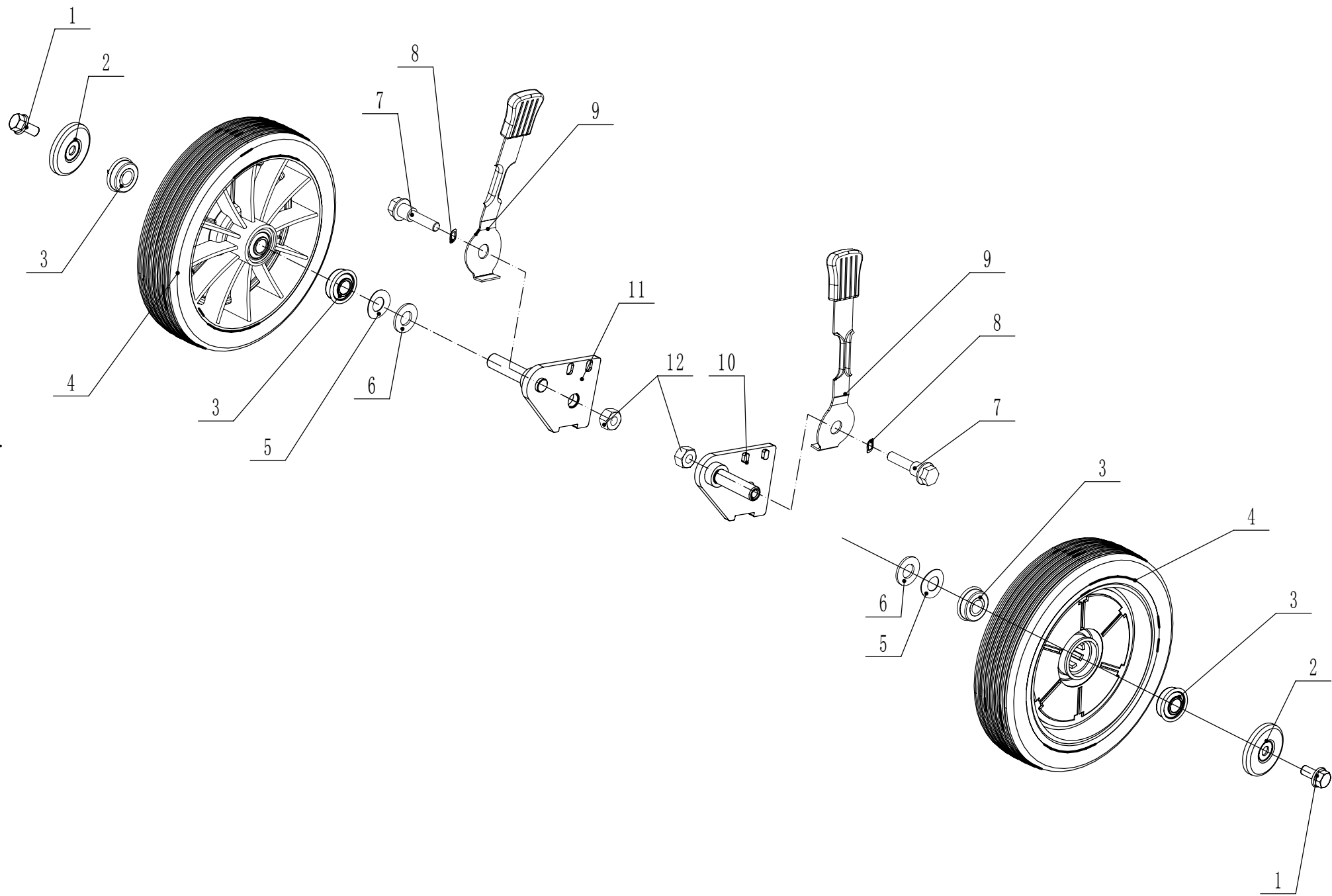

**3****Ersatzteilliste****WB 476 SK AL V P GL****2016**

<b>Nr.</b>	<b>Artikelnummer</b>	<b>Bezeichnung Deutsch</b>	<b>Bezeichnung Englisch</b>	<b>Anzahl</b>
1	0102008016	Bolzen	bolt	2
2	48R0210012/01	Abdeckscheibe	hub cap	2
3	5310213010	Lager	bearing	4
4	5380205010-47	Vorderrad	front wheel	2
5	5310211010/04	Unterlegscheibe	spring washer	2
6	5310210010/02	Scheibe	spacer	2
7	5340205010	Höhenverstellbolzen	bolt	2
8	5340507010	Unterlegscheibe	spacer	2
9	GM45D020100010	Verstellhebel	adjustment lever	2
10	5340201010/01	Radhalter (links)	arm weldment	1
11	5340202010/01	Radhalter (rechts)	arm weldment	1
12	0202008000	Sicherungsmutter	lock nut	2

# WB476 SK AL V S GL后轴总成

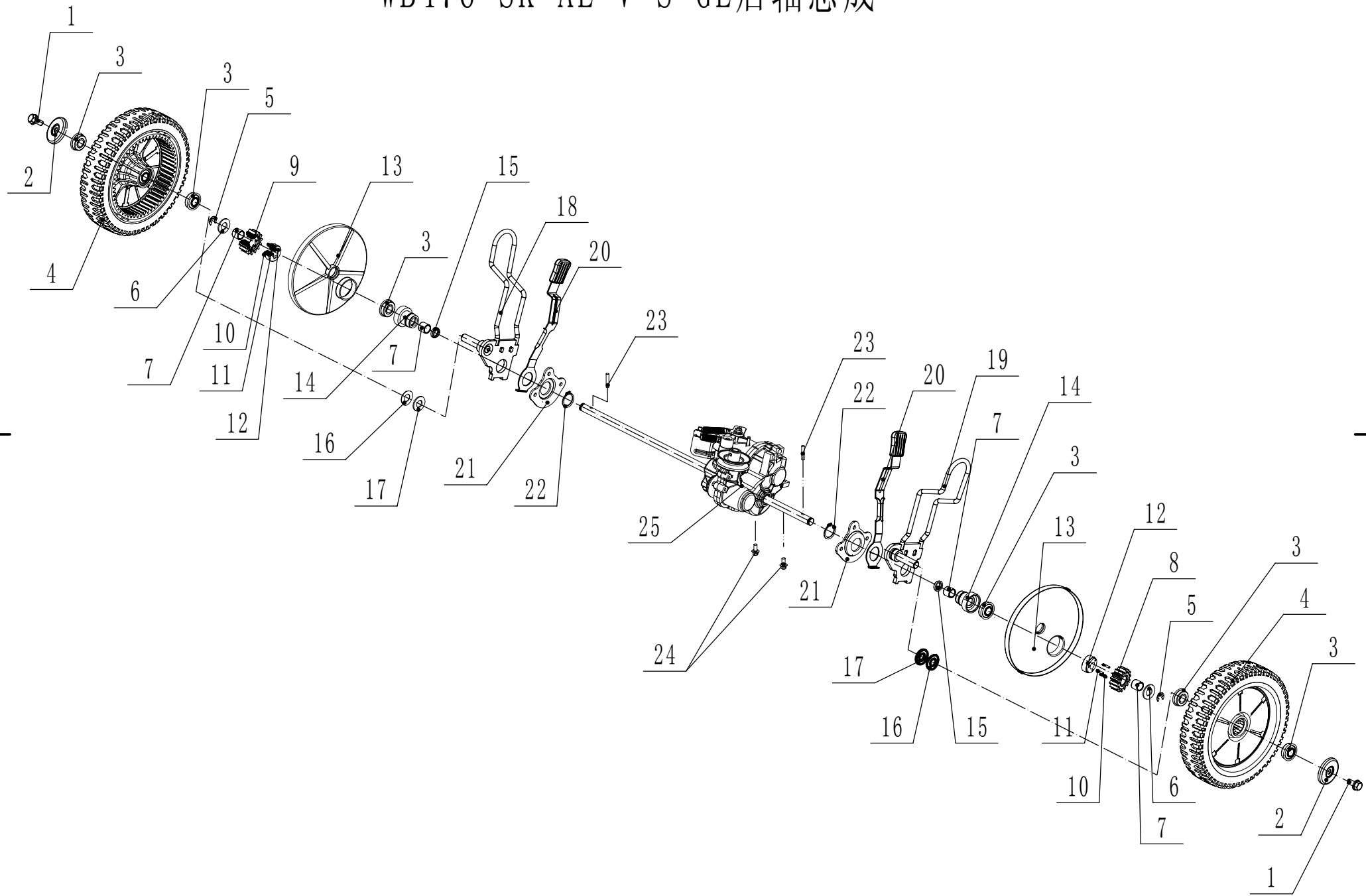

<b>4</b>	<b>Ersatzteilliste</b>	<b>WB 476 SK AL V P GL</b>	<b>2016</b>	
<b>Nr.</b>	<b>Ersatzteilnummer</b>	<b>Bezeichnung Deutsch</b>	<b>Bezeichnung Englisch</b>	<b>Anzahl</b>
1	0102008016	Bolzen	bolt	2
2	48R0210012/01	Abdeckscheibe	hub cap	2
3	5310213010	Lager	bearing	6
4	5380310010-47	Hinterrad	rear wheel	2
5	1301009000	Sicherungsring	check ring	2
6	5020311010/04	Scheibe	antifriction spacer	2
7	5320326010	Lager	bearing	4
8	HQ000100010	Zahnrad (links)	leftpinion	1
9	HQ000100020	Zahnrad (rechts)	right pinion	1
10	HQ000100030	Stift	pin	6
11	HQ000100040	Splint	spring	6
12	HQ000100050	Halter	pin seat	2
13	5340310010	Schutz	shield	2
14	5340308010/02	Lagerschutz	bush	2
15	5320327010	Staubabdeckung	antidust ring	2
16	5310211010/04	Unterlegscheibe	spring washer	2
17	5310210010/02	Scheibe	spacer	2
18	5340302010/01	Radhalter (rechts)	arm weldment	1
19	5340301010/01	Radhalter (links)	arm weldment	1
20	5340303010	Höhenverstellhebel	adjustment lever	2
21	5340305010	Hinterachsfeststellung	flange	2
22	1002024000	Ring	check ring	2
23	HQ000100060	Stift	pin	2
24	0101006018A	Schraube	lock screw	2
25	Y20460P0	Getriebe	transmission	1

# WB476 SK AL V S GL把手总成

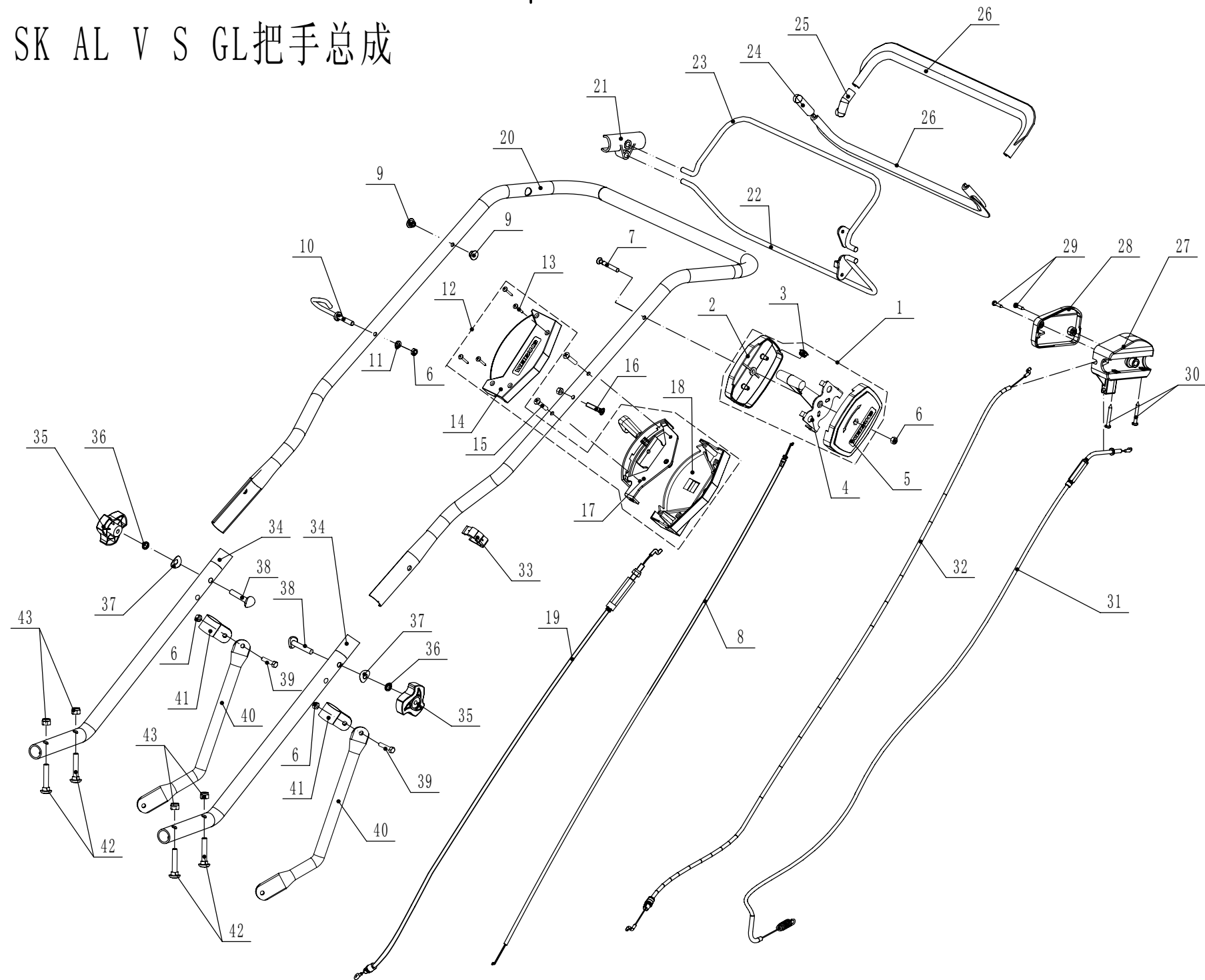

Nr.	Ersatzteilnummer	Bezeichnung Deutsch	Bezeichnung Englisch	Anzahl
2	4820520010	Rechtes gehäuse f. Gasgriff	right cover	1
3	4820520020	Schild	plug	1
4	4820518020	Gashebel	bracket	1
5	4820519010	Linkes Gehäuse f. Gasgriff	left cover	1
6	0202006000	Mutter	lock nut	5
7	0108006050	Schraube	screw	1
8	4320510011	Gaszug	throttle cable	1
9	4820513010	Deckel	plug	2
10	4510511010/01	Kabelhalter	hook	1
11	0301006000	Scheibe	spacer	1
13	0106004025	Schraube	cross slot ST screw	4
14	4820528010	Abdeckung	upper cover	1
15	0104006030	Bolzen	screw	2
16	0104006035	Schraube	screw	1
17	5340132010	Gehäuse	bracket	1
18	4820529010	Abdeckung	bottom cover	1
19	5340133010	Bowdenzug Geschwindigkeit	speed cable	1
20	GM45D040000000/22	Oberer Holm	upper handlebar weldment	1
21	4820511010	Klammer	bracket	1
22	4320512010/22	Griff	clutch lever weldment	1
23	4320503010/22	Hebel	brake lever weldment	1
24	4820510010	Hebel Abdeckung	knob	1
25	4820505010	Schutz	knob	1
26	5020505010	Hebel	sheath	2
27	4820515010	Kabelbox	lever bracket	1
28	4820516010	Abdeckung	cover	1
29	0106004016	Schraube	screw	2
30	0106005038	Schraube	screw	2
31	GM45D000000200	Kupplungskabel	clutch cable	1
32	4820538021	Bremskabel	brake cable	1
33	WTY0000	Kabelhalter	clip	1
34	GM45D000000060/22	Unterer Holm	lower handle	2
35	4820541010	Knopf	knob	2
36	401008000	Scheibe	spring washer	2
37	4510510010/01	Scheibe	arc washer	2
38	5310510010/01	Schraube	bolt	2
39	0101006025	Bolzen	bolt	2
40	GM45D000000170/22	Holmverstärkung	rod	2
41	GM45D000000160/22	Halter	clip	2
42	0107008045	Bolzen	bolt	4
43	0202008000	Sicherungsmutter	lock nut	4