

2 Main Body

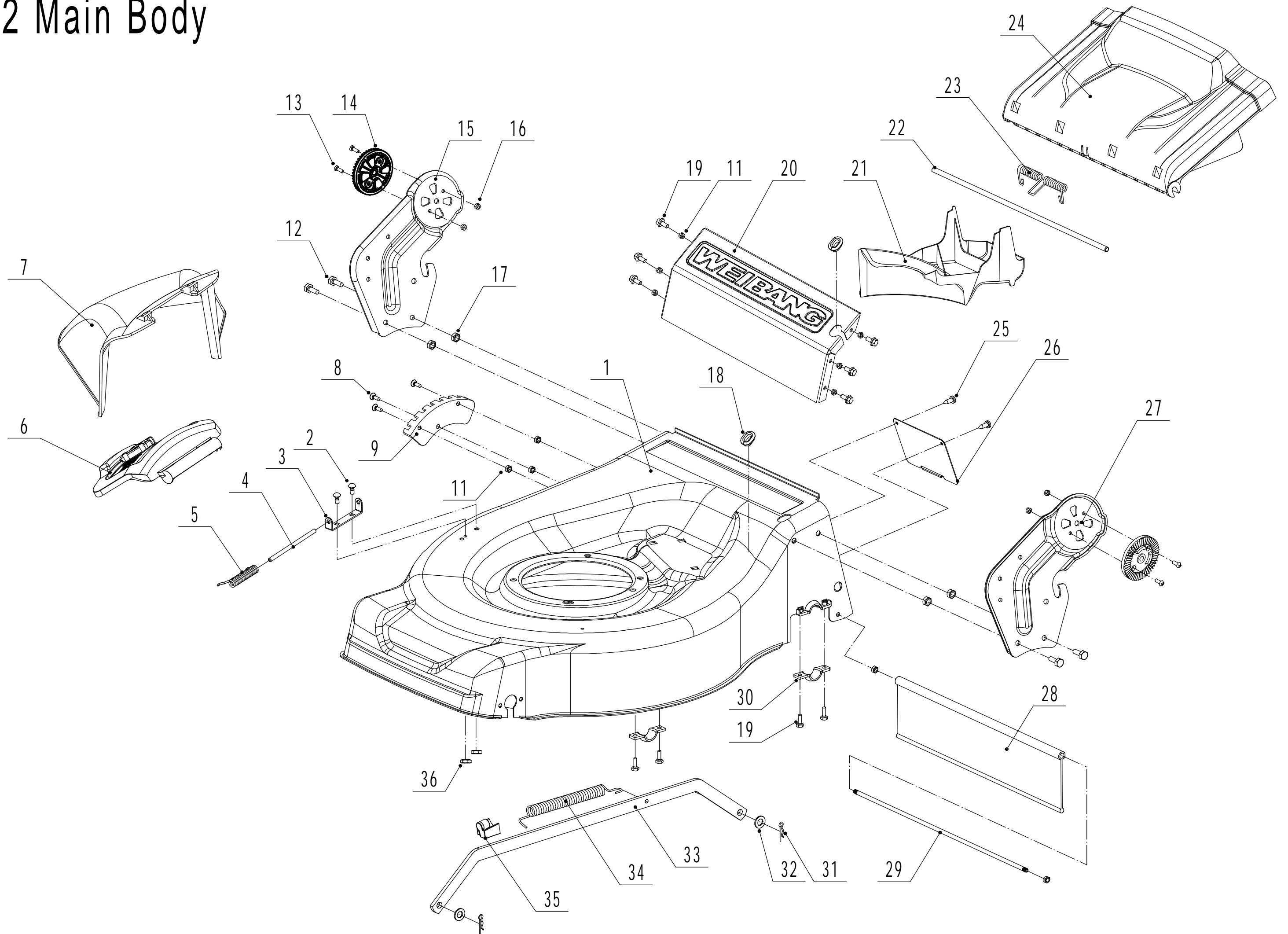

2	Ersatzteilliste		WB 537 SLC V 3-1	2021
Nr.	Ersatzteilnummer	Bezeichnung Deutsch	Bezeichnung Englisch	Anzahl
1	5360101010J/49	Gehäuse	Chassis	1
2	0107006014	Bolzen	Bolt - M6x14	2
3	5020118010/02	Federhalter	Side Discharge Cover Bracket	1
4	5020120010/02	Stange	Side Discharge Cover Spring	1
5	5020119010	Feder	Side Discharge Cover Pivot	1
6	5360119012	Seitenauswurfklappe	Side Discharge Cover Kit	1
7	5360120010J	Seitenauswurf	Side Discharge Deflector	1
8	0104006016	Schraube	Screw - M6x16	3
9	5360123010/01	Höhenverstellung	Graduator	1
11	0202006000	Sechskant Sicherungsmutter	Lock Nut - M6	9
12	0102008016	Bolzen	Bolt - M8x16	4
13	0104005012	Schraube	Screw - M5x12	4
14	AVSA000000040/22	Schnellverschluß (Holm)	Tooth Disc	2
15	5360125010K/40	AVS-Halterung	Right Handle Bracket	1
16	0202005000	Sicherungsmutter	Lock Nut - M5	4
17	0202008000	Sicherungsmutter	Lock Nut - M8	4
18	5360122010C	Gummiring	Rubber Ring	2
19	0102006012	Bolzen	Bolt - M6x12	10
20	5360124030/49	Verbindungsstück	Connector	1
21	5360115010	Mulchknopf	Mulching Plug	1
22	5360117010/02	Stange	Rod - Grass Bag Flap	1
23	5360118010	Feder	Spring - Grass Bag Flap	1
24	5360116010	Schutz	Grass Bag Flap	1
25	0106004009	Bolzen	Screw - ST4.2x9.5	2
26	5360105010D/49	Umlenblech	Baffle	1
27	5360124010K/40	AVS-Halterung	Left Handle Bracket	1
28	5360127010	Hinterer Schutz	Trailing Flap	1
29	5360126010/02	Stange	Pivot - Trailing Flap	1
30	5320114020/01	Halter	Upper Bearing Bracket	2
31	5320333010	Federsplint	Spring Clip	2
32	0301010000	Scheibe	Plain Washer - M10	2
33	5360308010/40	Verbindungsstange	Connector Rod	1
34	5320332010/01	Feder	Connecting Rod Spring	1
35	4560109012	Halterung	Spring Bracket	1
36	0204006000	Mutter	Lock Nut - M6	2

3 Blade System

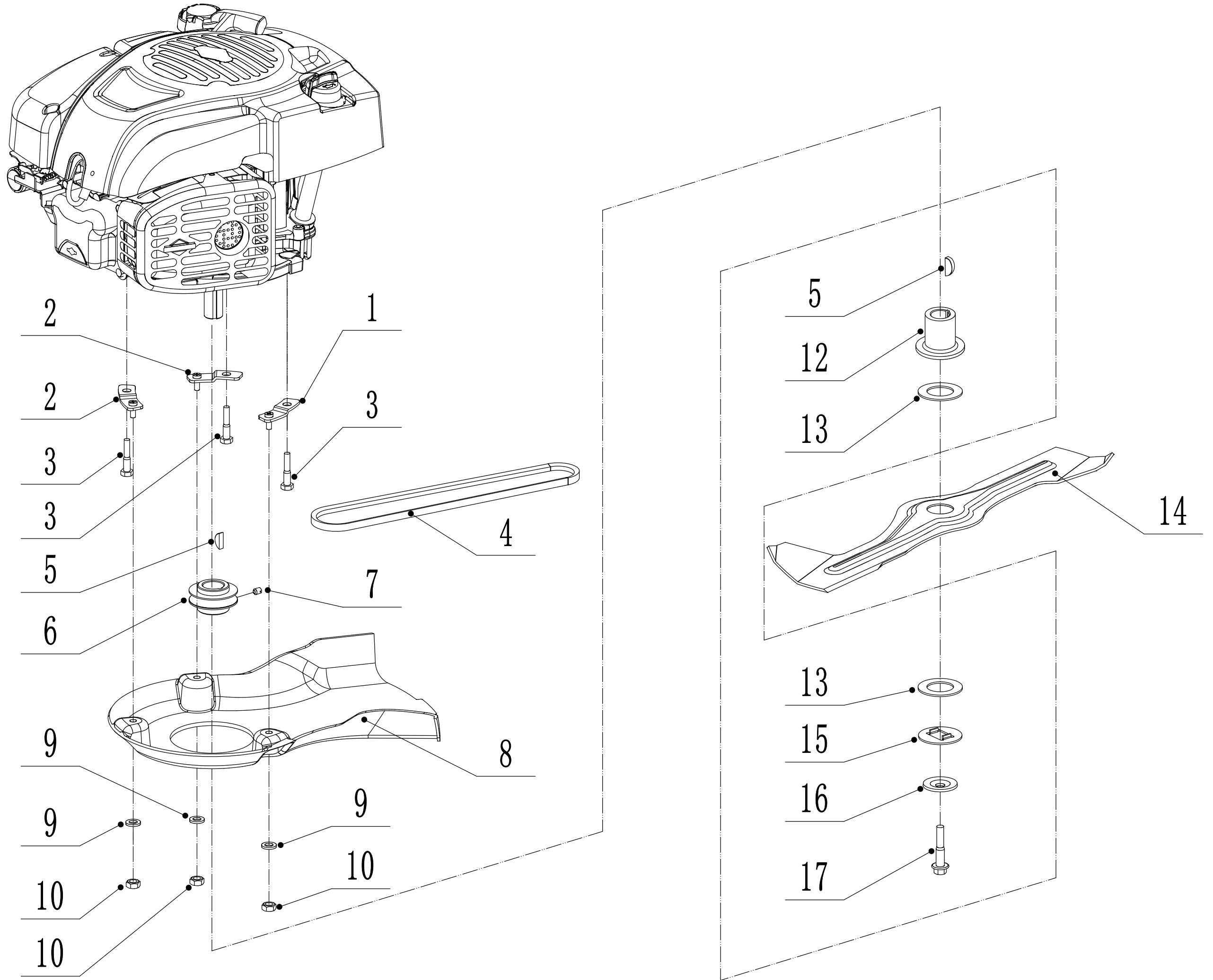

3	Ersatzteilliste WB 537 SLC V 3-1			2021
Nr.	Ersatzteilnummer	Bezeichnung Deutsch	Bezeichnung Englisch	Anzahl
1	5360111010/02	Unterlegscheibe	Engine Washer 1	1
2	5360112010/02	Unterlegscheibe	Engine Washer 2	2
3	5320115010	Schraube	Screw - 3/8x16x25	4
4	VB53V10/850S	Keilriemen	Belt - V10x850 (30°)	1
5	4510401010	Keil	Key	2
6	4560402040/02	Riemenscheibe	Engine Pulley	1
7	0105006006	Lochschraube	Screw - M6x6	1
8	5360113010	Riemenschutz	Belt Shield	1
9	0302006000	Scheibe	Plain Washer - M6	3
10	0202006000	Sechskant Sicherungsmutter	Lock Nut - M6	3
12	5320404020/02	Messerhalter	Adapter	1
13	5310402010	Friktionsscheibe	Friction Disc	2
14	5310403010A	Messer	Blade	1
15	5310404010/02	Ring	Locking Disc	1
16	5310406010/04	Scheibe	Spring Washer	1
17	5320405011	Messerbolzen 3/8x24x55	Blade Bolt - 3/8x24x55	1

4 Front axle

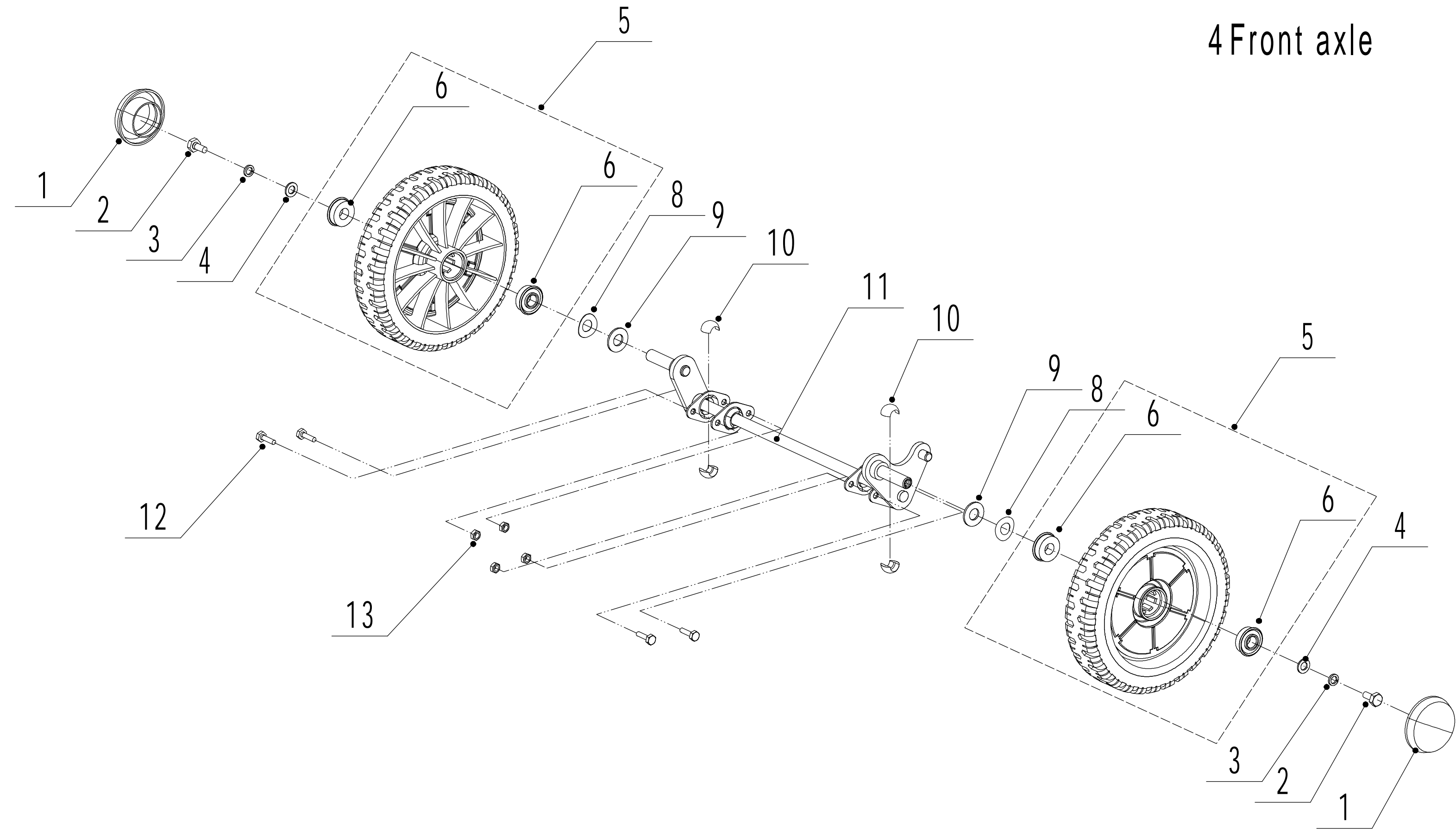

4	Ersatzteilliste WB 537 SLC V 3-1			2021
Nr.	Ersatzteilnummer	Bezeichnung Deutsch	Bezeichnung Englisch	Anzahl
1	5310214010	Radkappe	Wheel Cap	2
2	0101008015	Bolzen	Bolt - M8x15	2
3	0401008000	Federscheibe	Spring Washer - M8	2
4	0301008000	Unterlegscheibe	Flat Washer	2
5	5310212010/40	Rad	Wheel - 8"	2
6	5310213010	Lager	WEIBANG Bearing	4
8	5310211010/02	Federscheibe	Spacer	2
9	5310210010/02	Scheibe	Plain Washer	2
10	5310209010	Lager	Spherical Bearing	4
11	5360201010/01	Vorderachse	Front Axle Weldment	1
12	0102006016	Flanschschraube	Bolt - M6x16	4
13	0202006000	Sechskant Sicherungsmutter	Lock Nut - M6	4

5 Rear axle

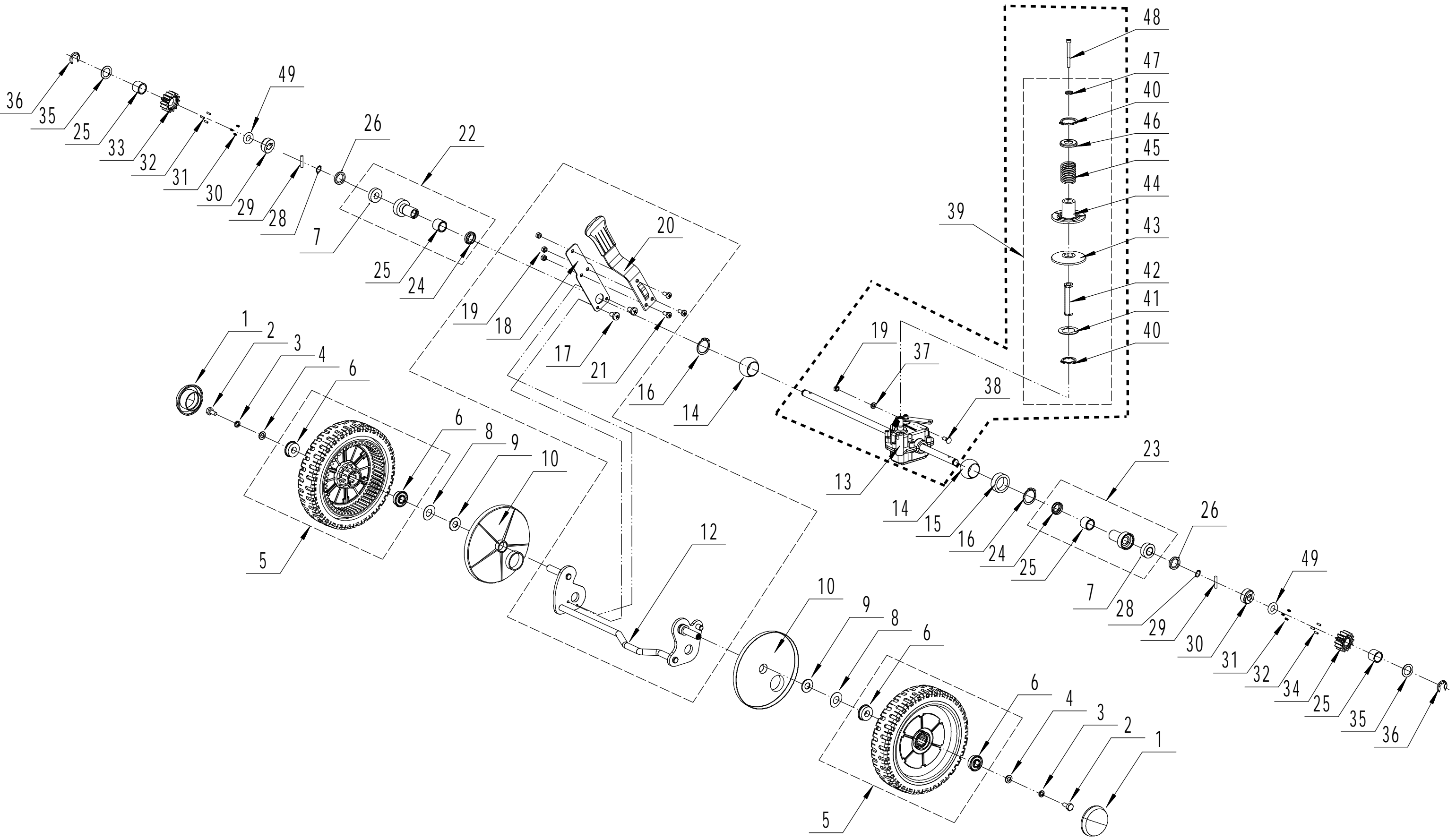

5	Ersatzteilliste		WB 537 SLC V 3-1	2021
Nr.	Ersatzteilnummer	Bezeichnung Deutsch	Bezeichnung Englisch	Anzahl
1	5310214010	Radkappe	Wheel Cap	2
2	0101008015	Bolzen	Bolt - M8x15	2
3	0401008000	Federscheibe	Spring Washer	2
4	0301008000	Unterlegscheibe	Flat Washer	2
5	5340309010/40	Antriebsrad Kunststoff	Wheel	2
6	5310213010	Lager	Bearing	4
7	R8-2RS	Kugellager	Bearing	2
8	5310211010/02	Federscheibe	Spacer	2
9	5310210010/02	Scheibe	Wheel Axis Washer	2
10	5340312010	Schutz	Anti-Dust Shield	2
12	5360301010/01	Hinterachse	Rear Axle Weldment	1
13	Y20536V0P	Getriebe	Rear Transmission Assembly	1
14	5320328010	Nylon Lager	Nylon Spherical Bearing	2
15	4520313010/02	Buchse	Rear Axle Partition	1
16	1001020000	Sicherungsring für Welle	Check Ring For Shaft	2
17	0113005008	Schraube	Screw - M5x8	2
18	5360311010/22	Halter	Spring Of Adjustment Lever	1
19	0202006000	Sechskant Sicherungsmutter	Lock Nut - M6	3
20	5360310010/40	Höhenverstellhebel	Adjustment Lever	1
21	0101006014	Bolzen M6x14	Bolt - M6x14	3
22	Y065321	Lager	Right Bearing Sheath Assembly	1
23	Y065320	Lager	Left Bearing Sheath Assembly	1
24	5320327010	Staubabdeckung	Dustproof Ring	2
25	5320326010P	BUCHSE	Bearing	4
26	GM48S010000010	Ring	Spacer	2
28	1001012000	Ring	Check Ring For Shaft	2
29	HQ000100060	Stift	Pin For Ratchet	2
30	HQ000100050	Halter	Ratchet	2
31	HQ000100040	Feder	Spring	6
32	HQ000100030	Stift	Pin	6
33	HQ000100020	Zahnrad (rechts)	Right Drive Pinion	1
34	HQ000100010	Zahnrad (links)	Left Drive Pinion	1
35	5020311010/04	Scheibe	Friction Mat	2
36	1301009000	Sicherungsring	Check Ring	2
37	0301006000	Scheibe	Flat Washer	1
38	0107006014	Bolzen	Bolt - M6x14	1
39	Y115380	Ring	Speed Variator Assembly	1
40	1001017000	Sicherungsring	Check Ring For Shaft	2
41	4820320010/02	Scheibe	Inner Hex Washer	1
42	4820321010/02	Schutz	Hex Adapter	1
43	5380309010	Scheibe	Lower Pulley Disc	1

44	5380308010	Variatorhälfte	Active Pulley Disc	1
45	4820324010	Feder	Pressing Spring	1
46	4820325010/02	Federschutz	Spring Cap	1
47	0401005000	Scheibe	Spring Washer	1
48	0103005055	Innensechskantschraube	Bolt - M5x55	1
49	1401025015	Ring	O Sealing Ring	2

6 Handle And Controls

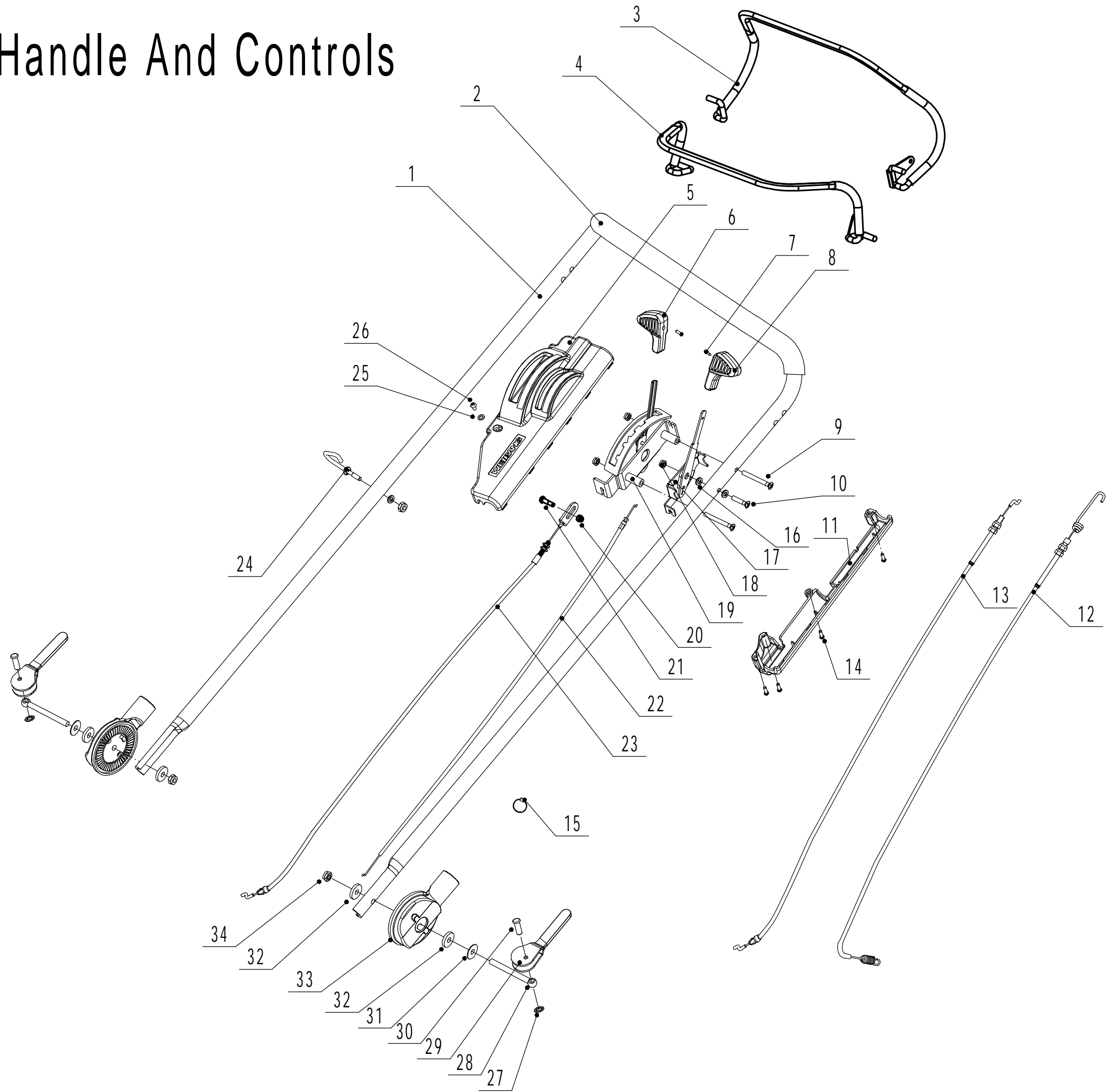

6	Ersatzteilliste		WB 537 SLC V 3-1	2021
Nr.	Ersatzteilnummer	Bezeichnung Deutsch	Bezeichnung Englisch	Anzahl
1	GM53C01000001B/49	Griff	Handle	1
2	GM56E010000081	Griffschutz	Handle Sheath	1
3	5320511030S/40	Kupplungshebel	Clutch Lever	1
4	5320503020S/40	Hebel	OPC Lever	1
5	5020501030S	Schutz	Control Cover - Upper	1
6	5380508010	Knopf Geschwindigkeit schwarz	Speed Control Grip	1
7	0106003013	Schraube	Screw - ST2.9x13	2
8	5380510010	Kappe für Gasgriff	Throttle Control Grip	1
9	0108006060	Schraube	Screw - M6x60	2
10	0108006050	Schraube	Screw - M6x50	1
11	5020501040S	Schutz	Control Box Lower Cover	1
12	LH194-1225	Kupplungskabel	Clutch Cable	1
13	BS120-1180	Motorbremskabel	OPC Cable (Engine Brake)	1
14	0113040018	Schraube	Screw	4
15	ZD8/200	Kabelbinder	Cable tie	1
16	0301006000	Scheibe	Washer - M6	7
17	5380512010	Hebel	Throttle Control Bracket	1
18	0202006000	Sechskant Sicherungsmutter	Lock Nut - M6	4
19	5360505010K	Geschwindigkeitsregulierung	Speed Control Bracket	1
20	0202005000	Sicherungsmutter	Lock Nut - M5	1
21	5360506011	Schraube	Speed Control Cable bolt	1
22	YM72-1080-A	Gaszug	Throttle Cable	1
23	TX130-1060-A	Geschwindigkeitsregelungskabel	Speed Control Cable	1
24	4510511010/01	Kabelhalter	Hook - Starter Rope	1
25	0301005000	Unterlegscheibe	Washer - M5	1
26	0104005008	Bolzen	Screw - M5x8	1
27	4510114030	Buchse	Fix Cap	2
28	GM48S000000100	Bolzen	Connecting Bolt	2
29	GM56A100400000	Hebel	Lock Lever	2
30	0801008025	Stift	Axis Pin - 8x25	2
31	GM56A100000040/04	Scheibe	Spacer	2
32	GM56A100000050/01	Scheibe	Spacer	4
33	GM48S030200000	Verstellsegment	Tooth Disc Kit	2
34	0203008000	Mutter	Lock Nut - M8	2

7 Grass Catcher

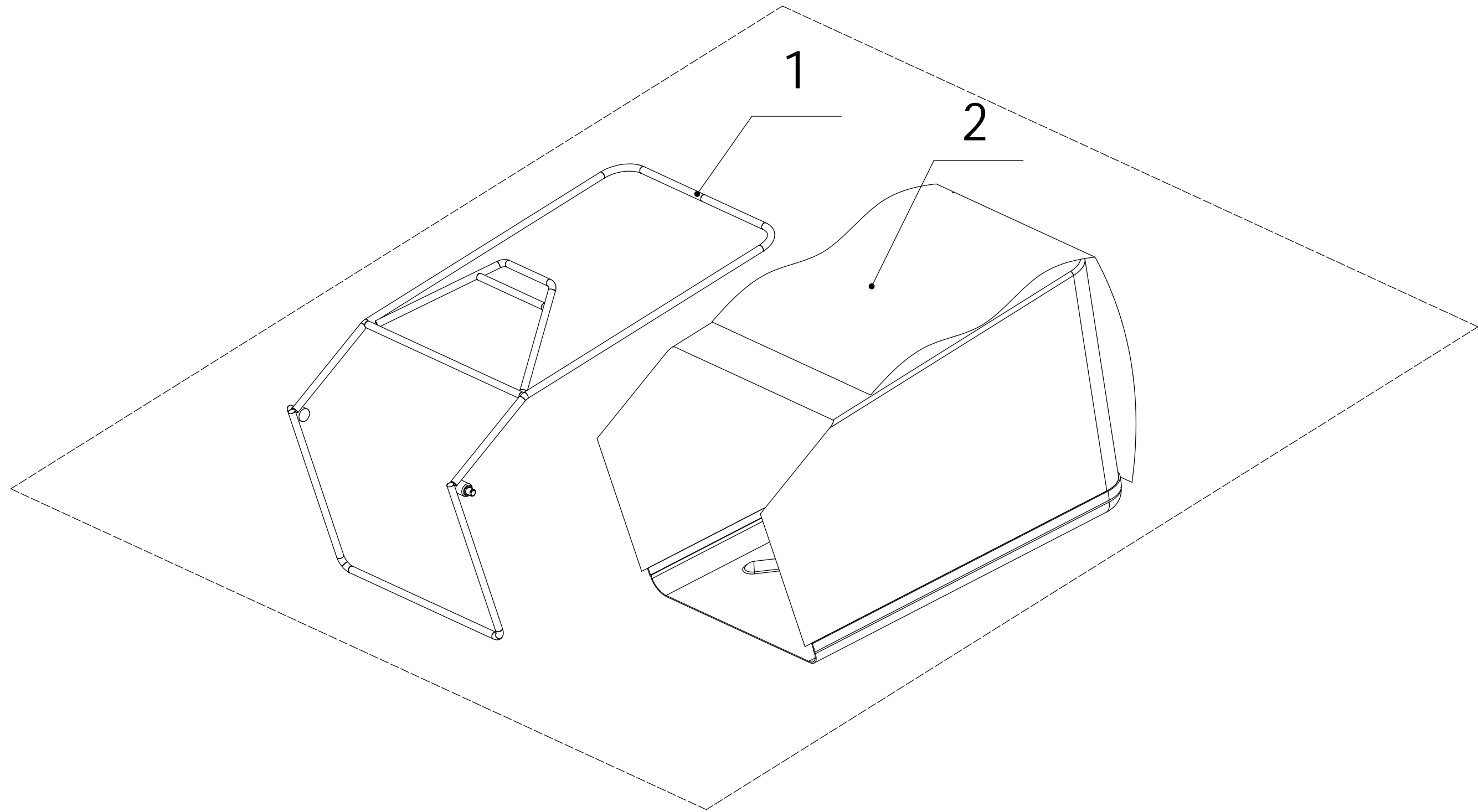

7	Ersatzteilliste WB 537 SLC V 3-1			2021
Nr.	Ersatzteilnummer	Bezeichnung Deutsch	Bezeichnung Englisch	Anzahl
1	5360602010T/22	Gestell	Grass Bag Frame	1
2	5360603010T/84	Fangsack	Grass Bag	1

8 Variable Speed Pulley

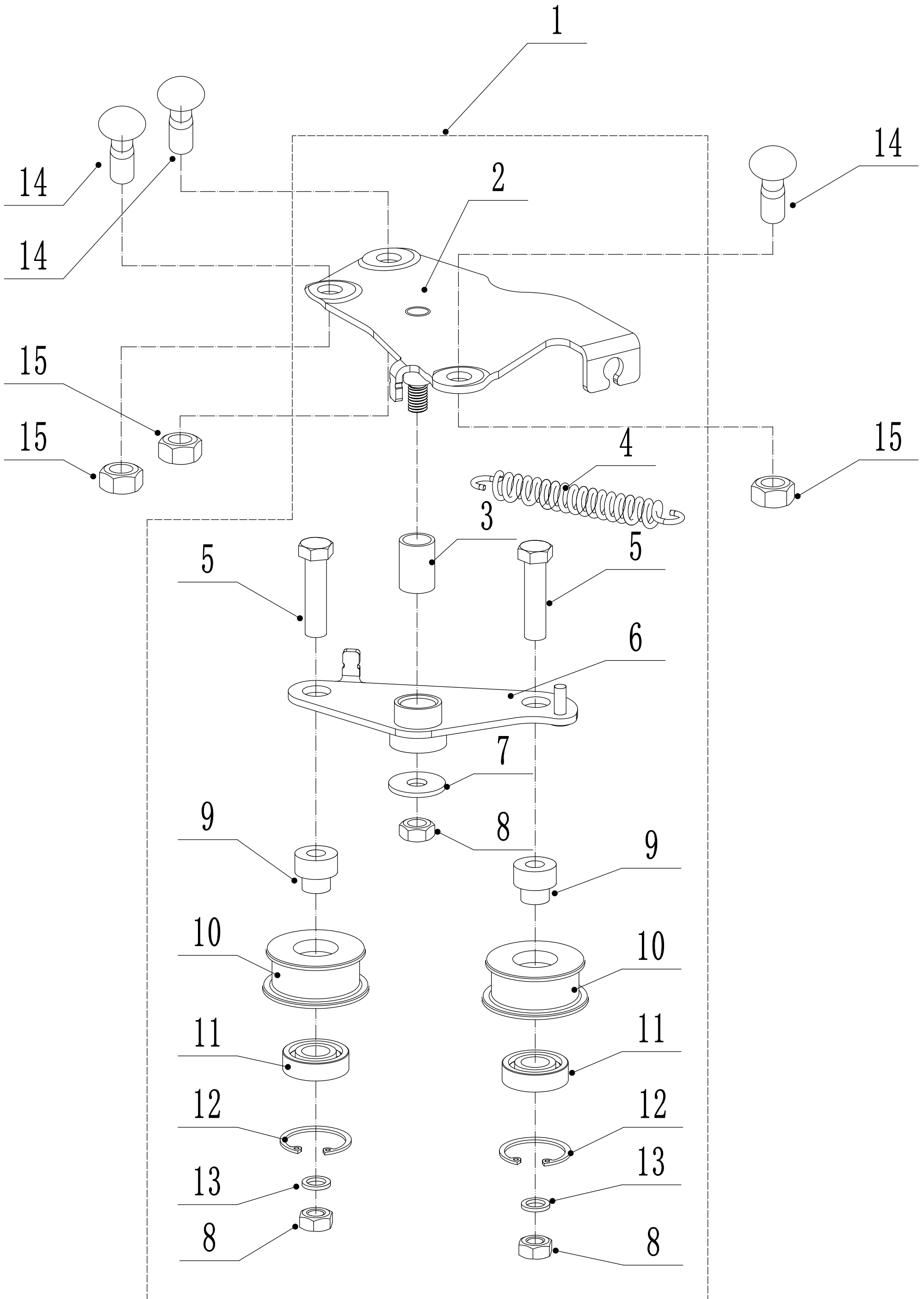

8	Ersatzteilliste WB 537 SLC V 3-1			2021
Nr.	Ersatzteilnummer	Bezeichnung Deutsch	Bezeichnung Englisch	Anzahl
1	Y095360	Getriebe	Belt Tensioner Assembly	1
2	5360129010/02	Halter	Tensional Arm Bracket	1
3	4820112010	Kunststoffbuchse	Nylon Bush	1
4	4820114010	Feder	Tensional Spring	1
5	4820120010	Spannbolzen	Bolt	2
6	5360130010/02	Spannarm	Tensional Arm Weldment	1
7	0302008000	Unterlegscheibe	Washer - M8	1
8	0202008000	Sicherungsmutter	Lock Nut - M8	3
9	5360131020/02	Hülse	Tensional Pulley Spacer	2
10	4820119010	Spannrolle	Tensional Pulley	2
11	6001/2RZ	Kugellager	Bearing	2
12	0901028000	Sicherungsring	Internal Circlip - M28	2
13	0301008000	Unterlegscheibe	Plain Washer - M6	2
14	0107010025	Bolzen	Bolt - M10x25	3
15	0202010000	Sicherungsmutter	Lock Nut - M10	3